

10.00 inches [25.40 cm]

7.50 inches [19.05 cm]

inches

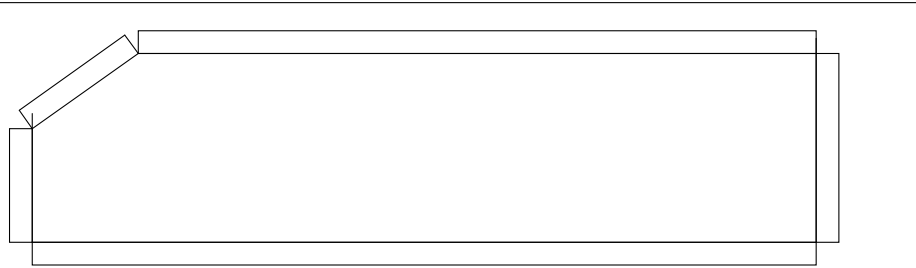
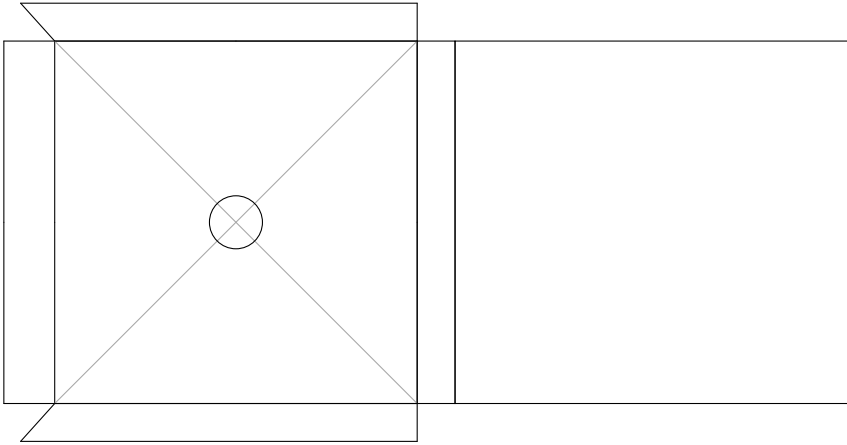

Loadingplate

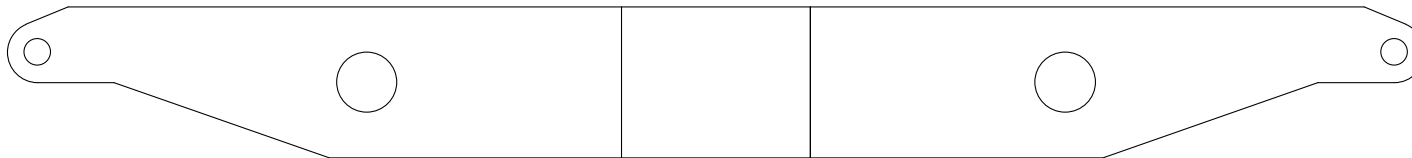
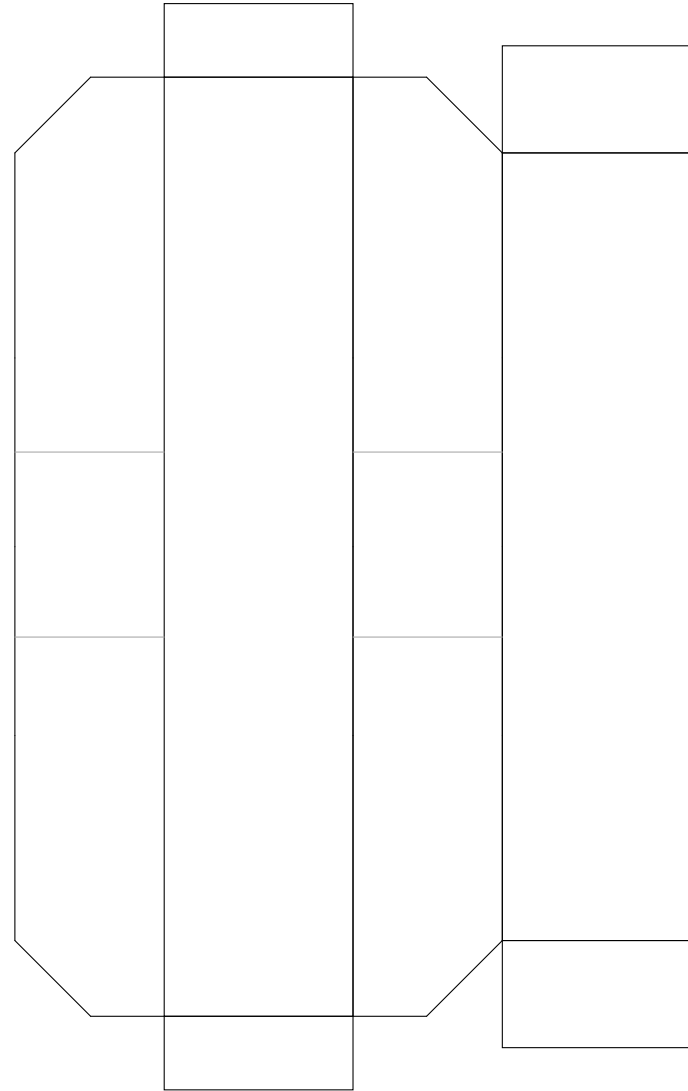
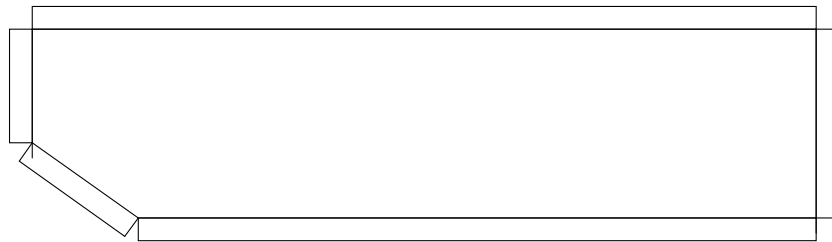

Gooseneck

inches

cm

cm

Gooseneck

10.00 inches [25.40 cm]

7.50 inches [19.05 cm]

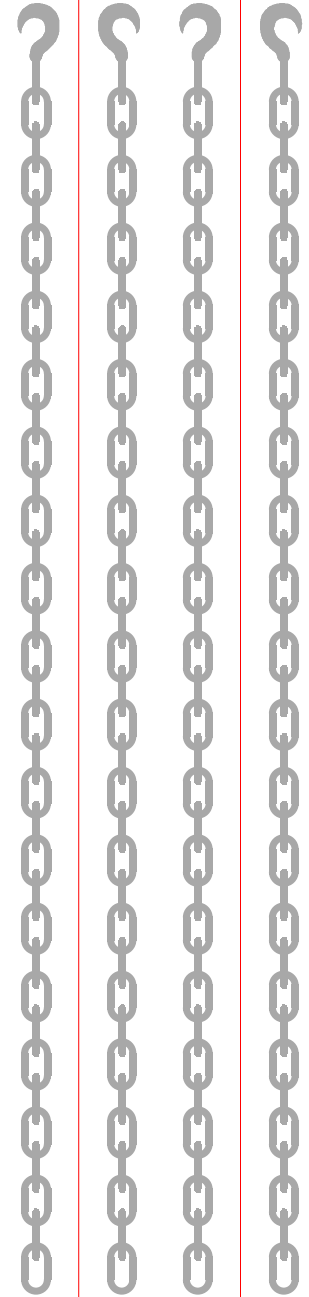
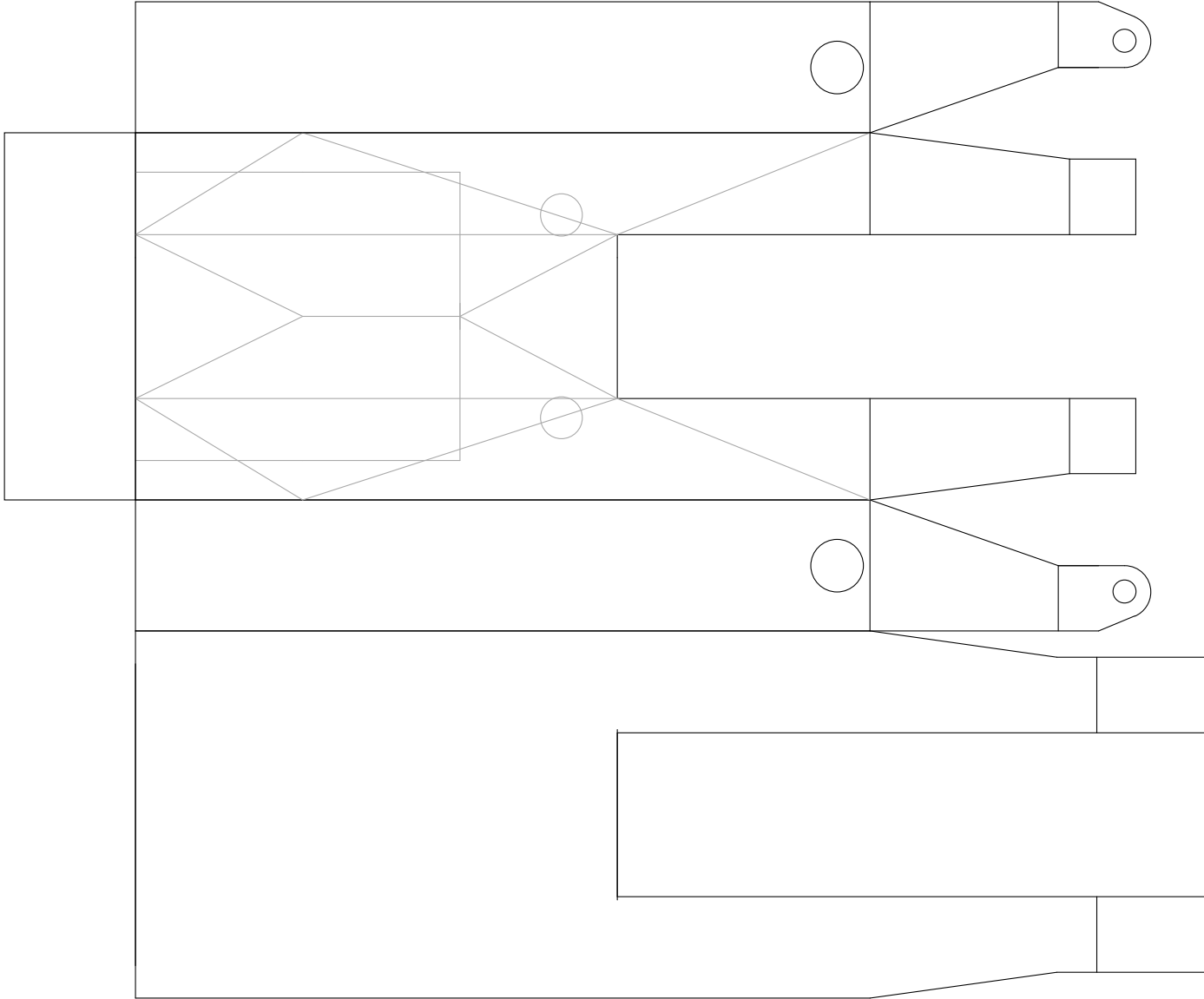

inches

cm

cm

inches

10.00 inches [25.40 cm]

inches

7.50 inches [19.05 cm]

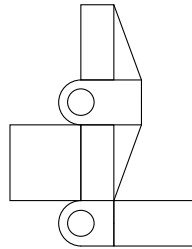
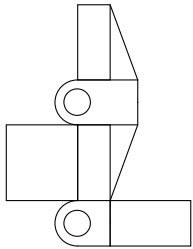
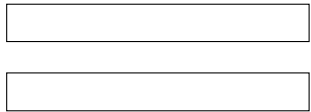
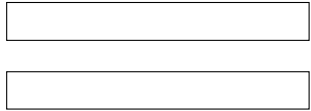
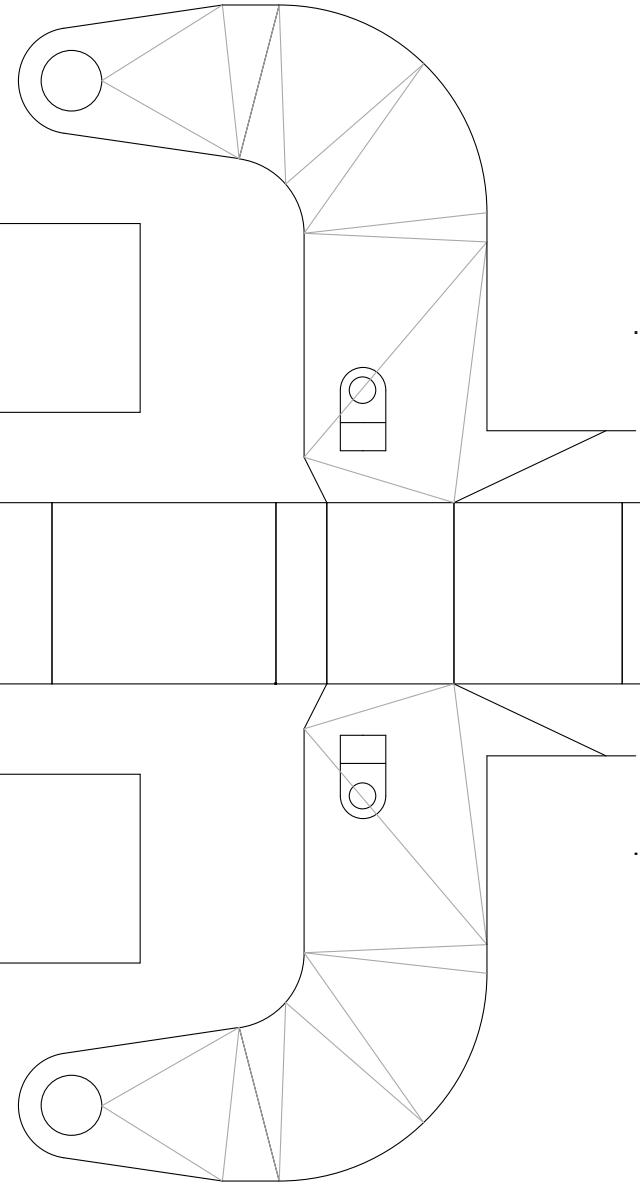
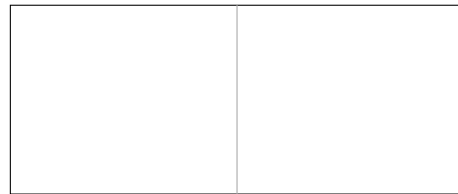
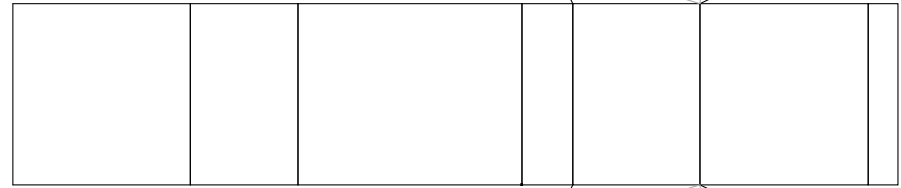
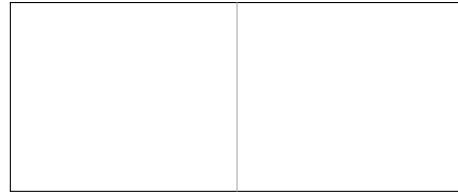
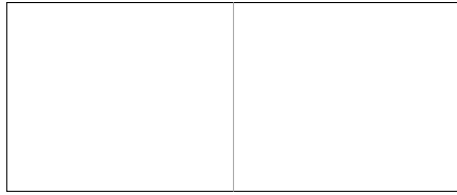
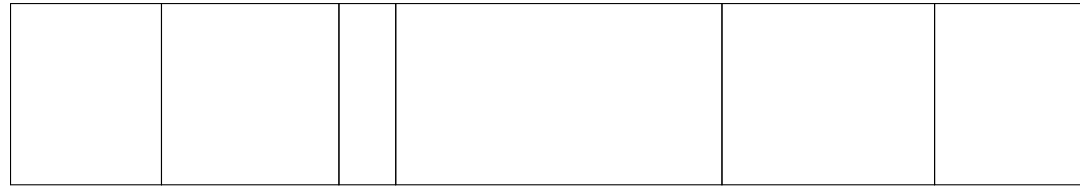

Gooseneck

inches

cm

cm

10.00 inches [25.40 cm]

7.50 inches [19.05 cm]

inches

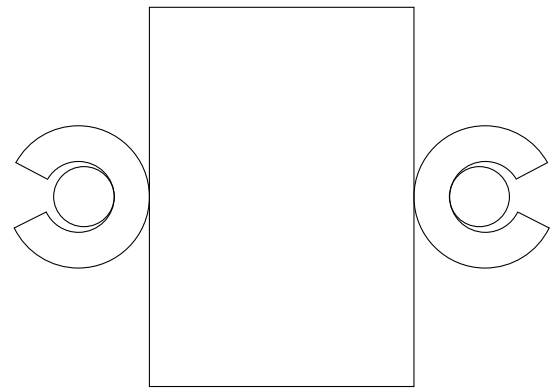
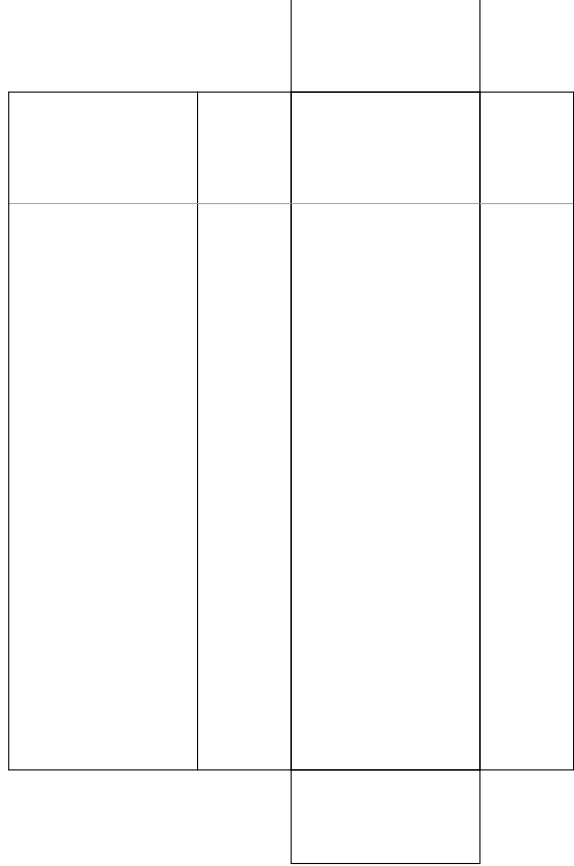
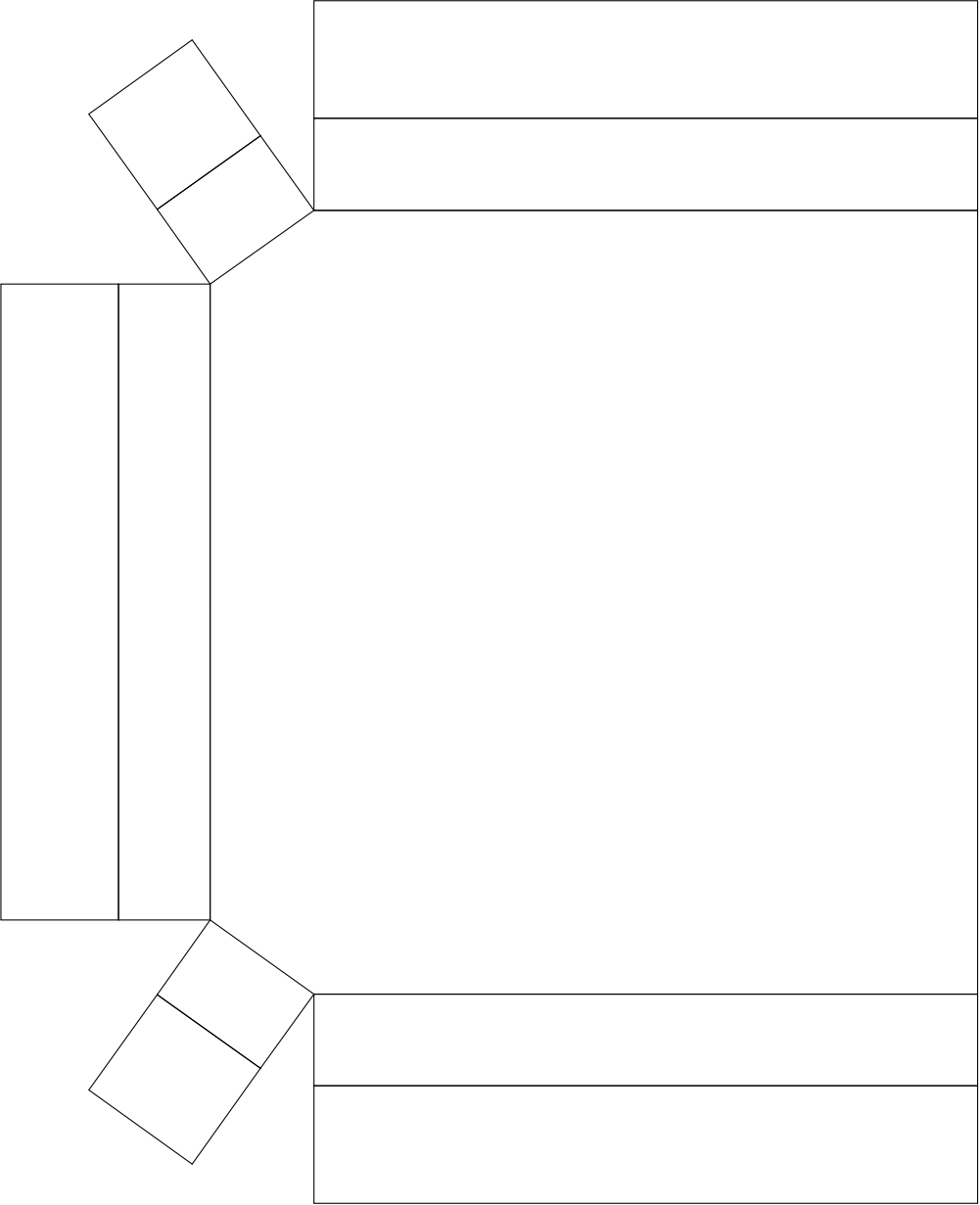

Loadingplate

inches

cm

cm

10.00 inches [25.40 cm]

7.50 inches [19.05 cm]

inches

cm

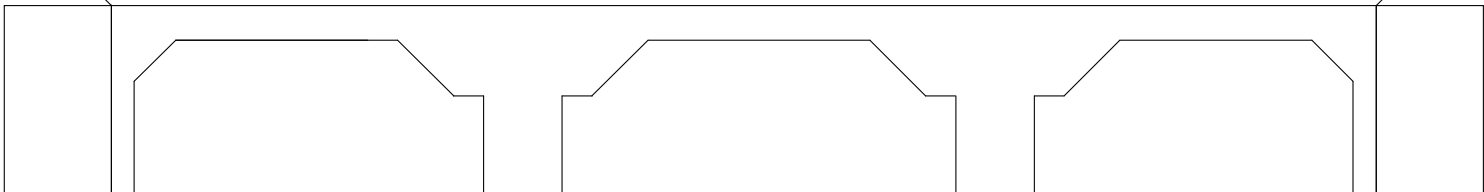
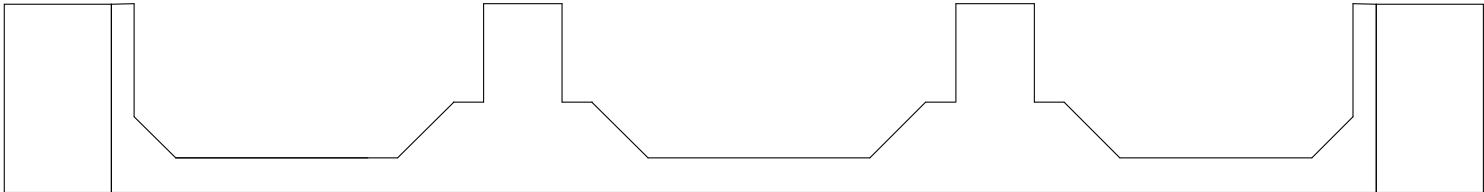

Axlcarrier

inches

cm

10.00 inches [25.40 cm]

7.50 inches [19.05 cm]

inches

cm

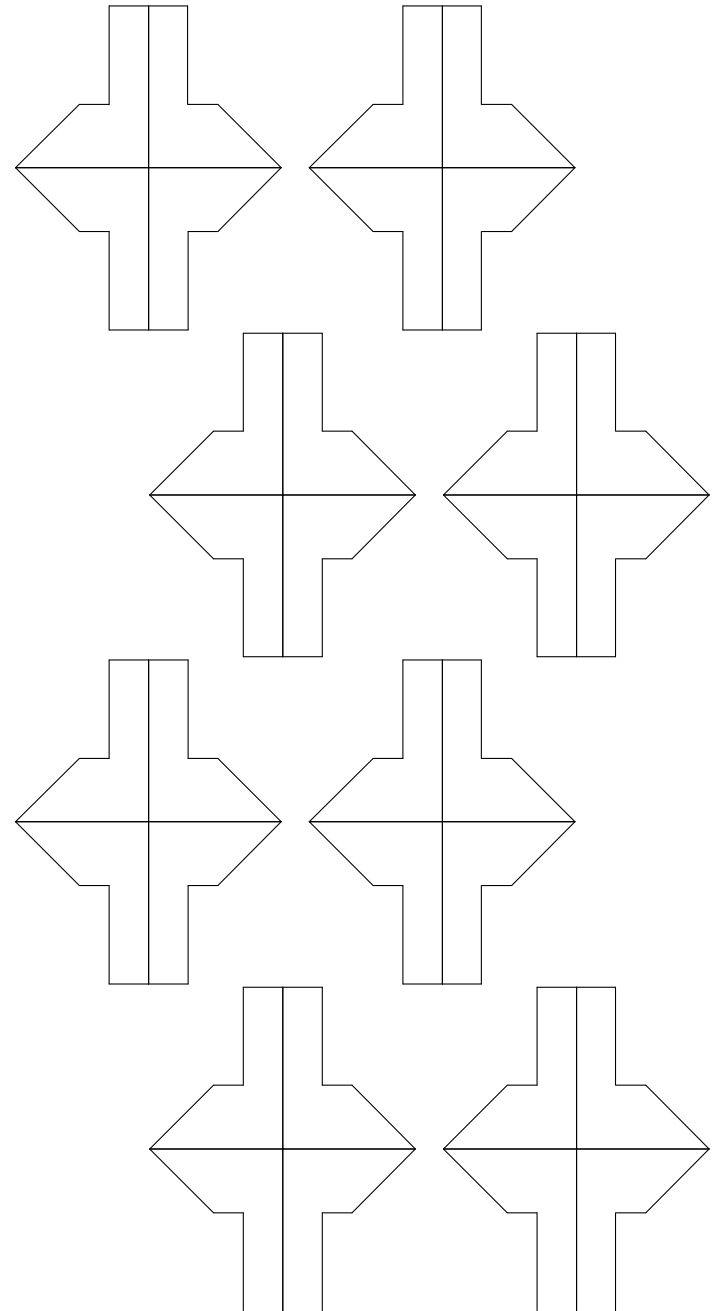
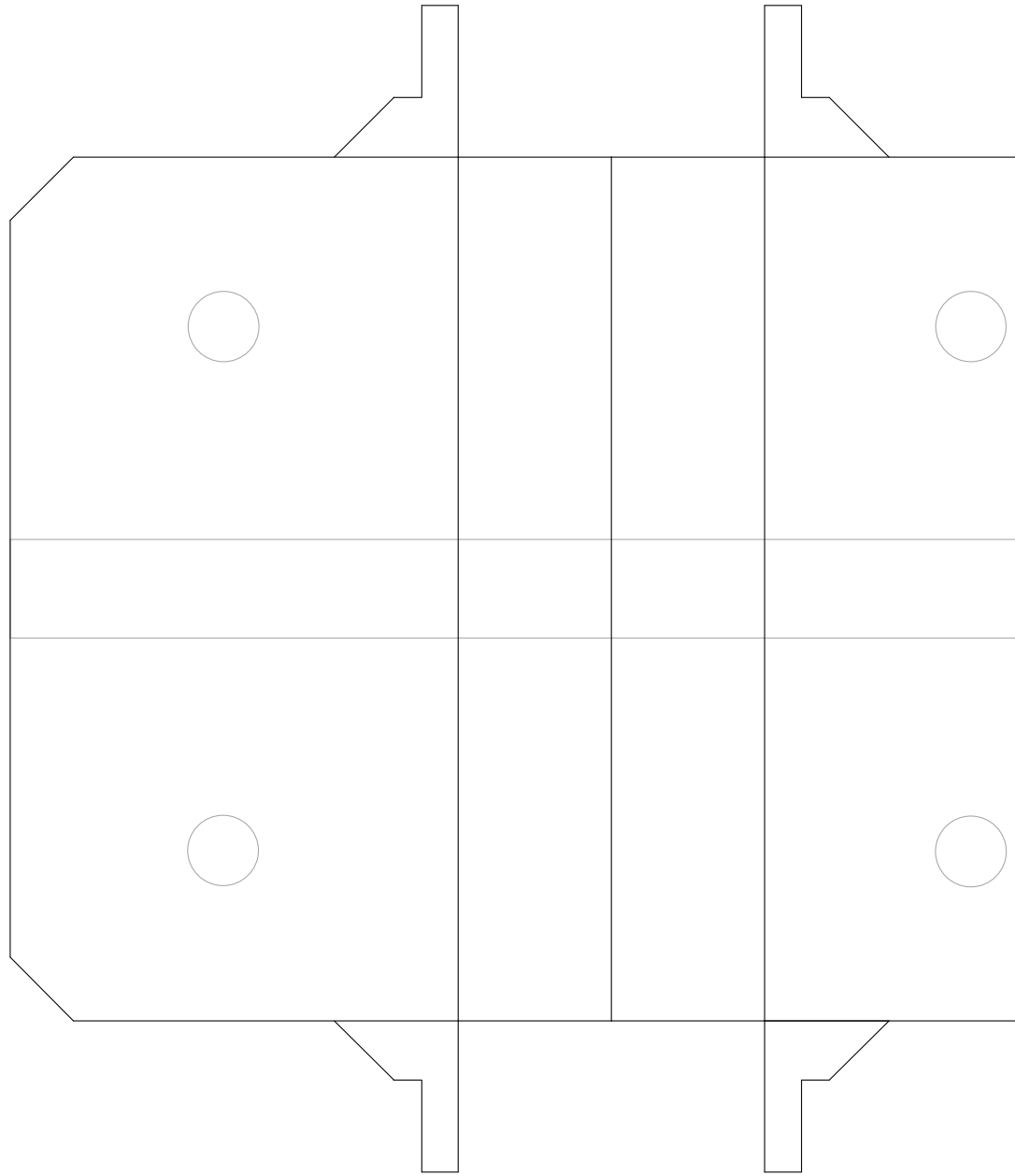

Axlcarrier

inches

cm

10.00 inches [25.40 cm]

7.50 inches [19.05 cm]

inches

cm

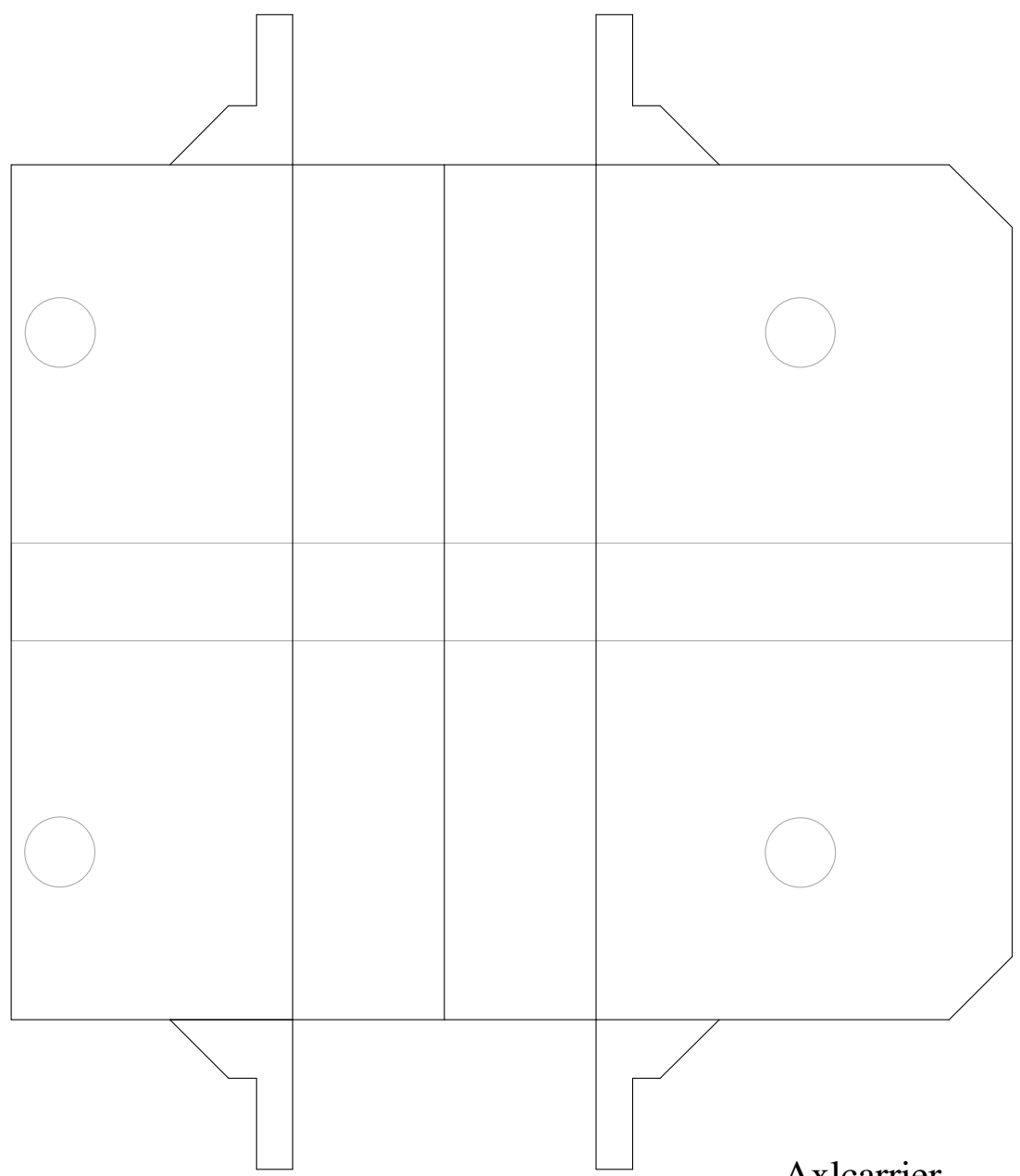
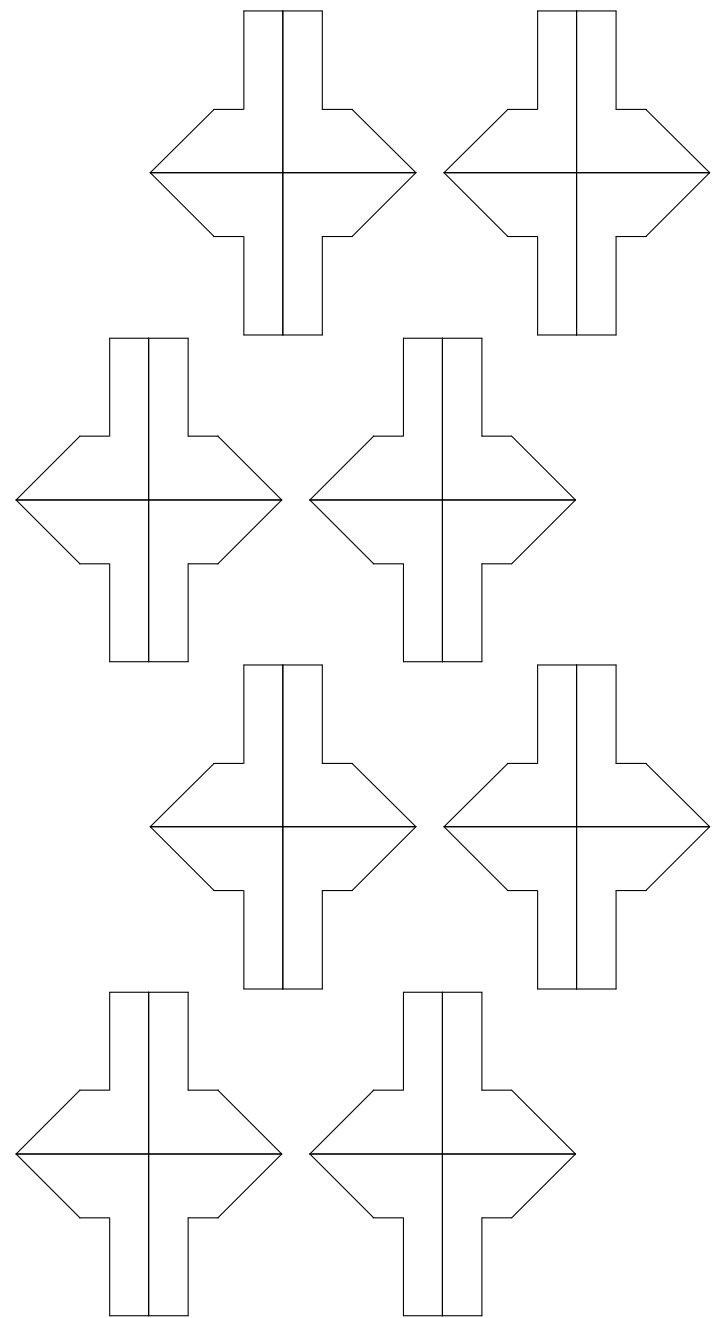

Axlcarrier

inches

cm

10.00 inches [25.40 cm]

inches

7.50 inches [19.05 cm]

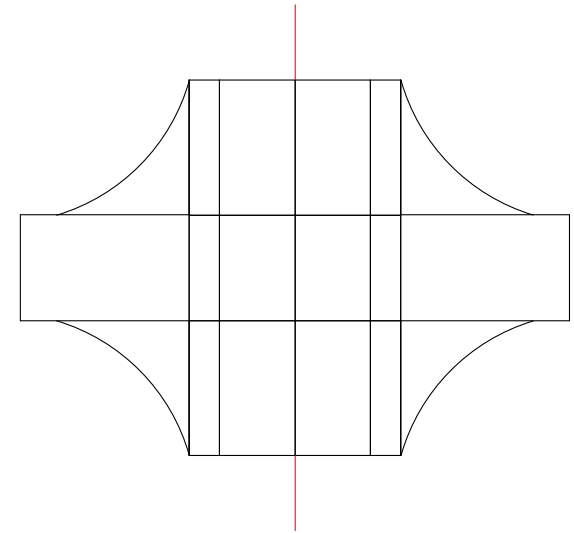
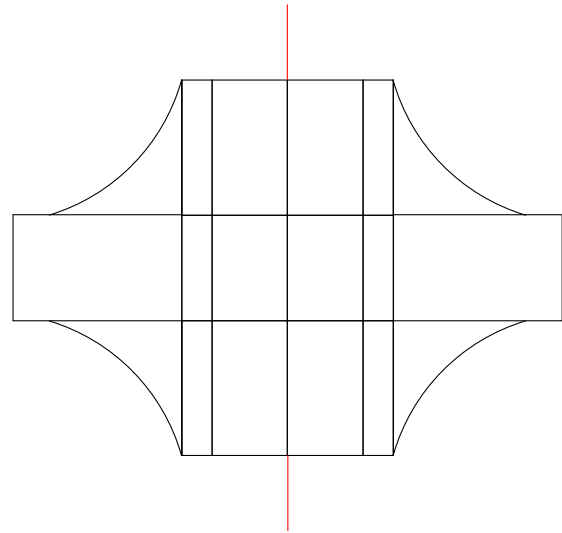
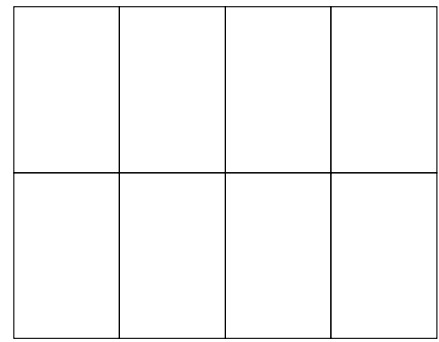
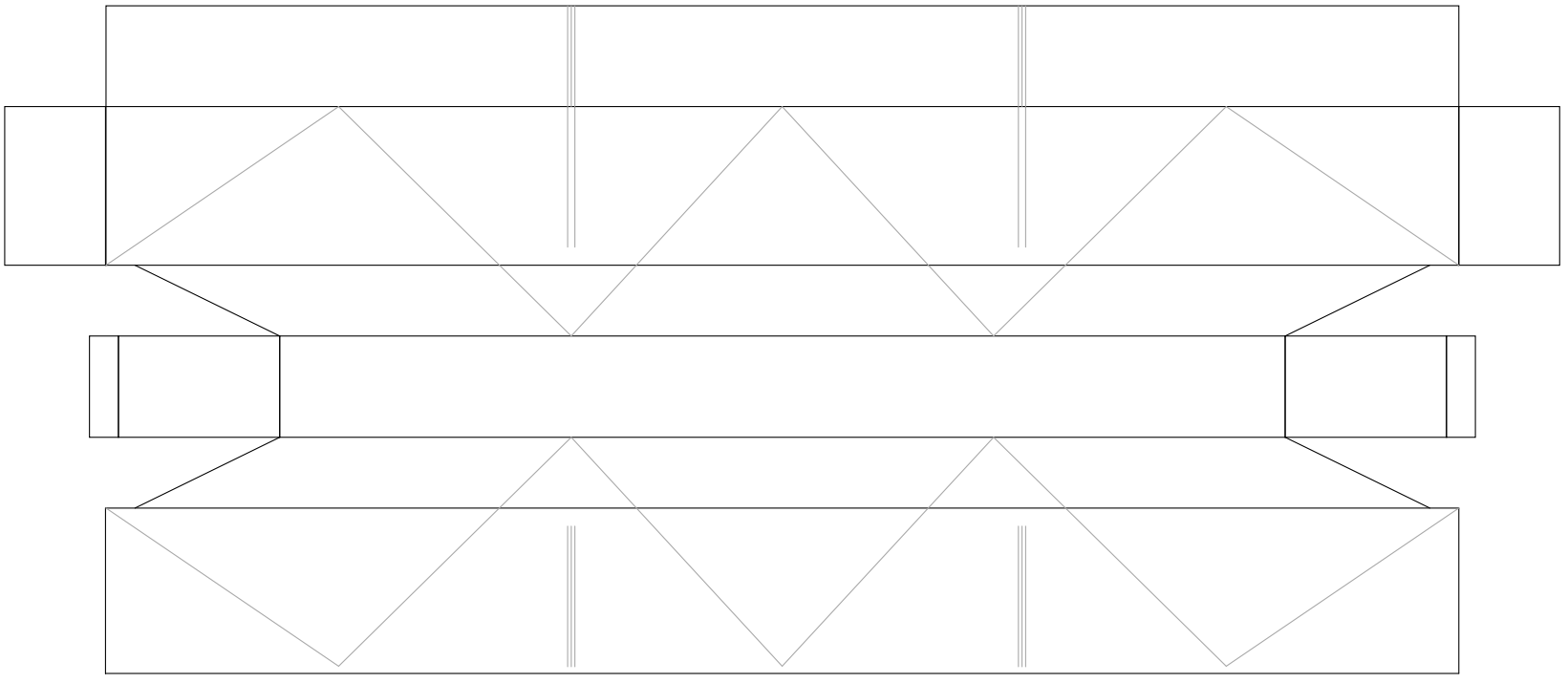

Axlcarrier

inches

cm

cm

10.00 inches [25.40 cm]

7.50 inches [19.05 cm]

inches

cm

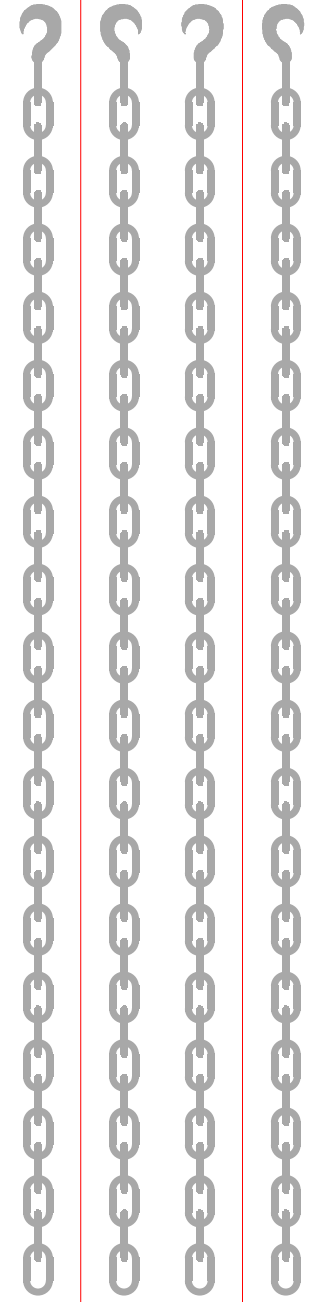
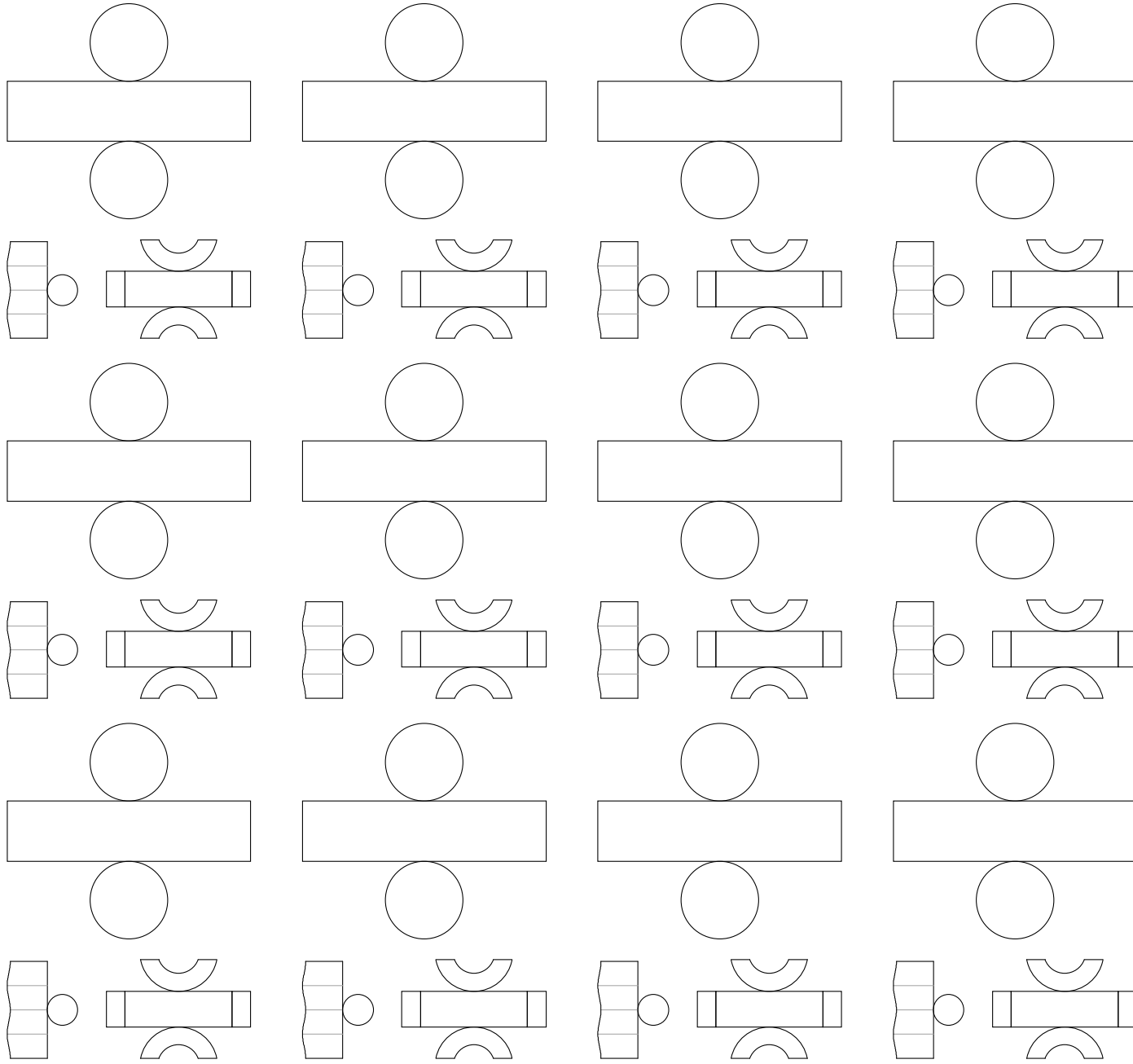

Brakes

inches

cm

10.00 inches [25.40 cm]

inches

Axles

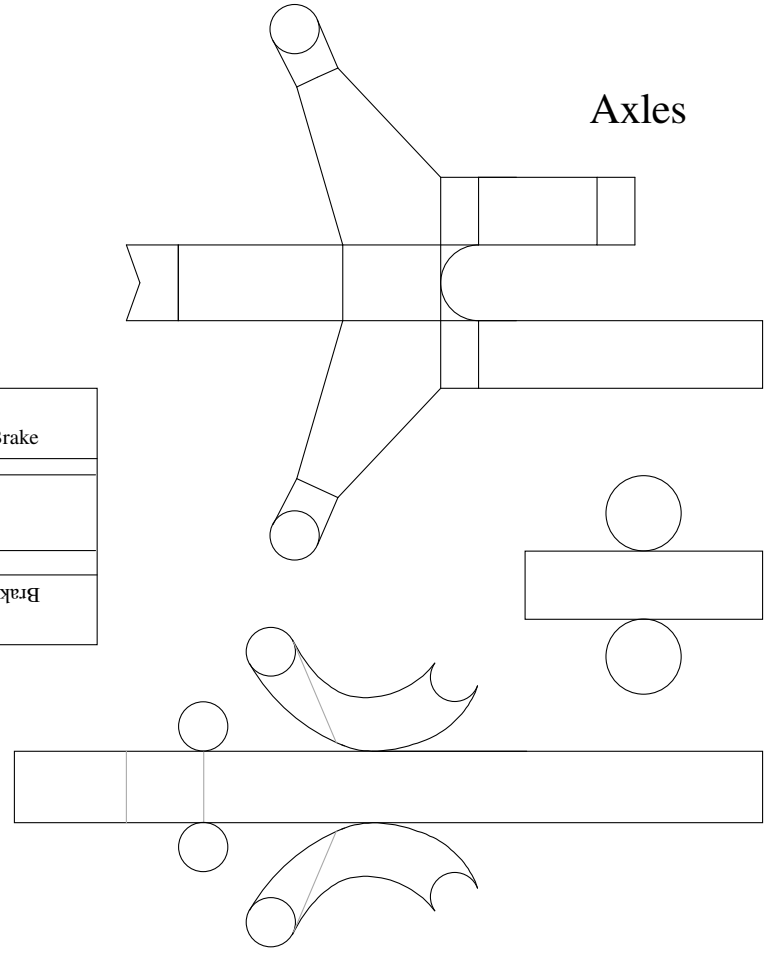
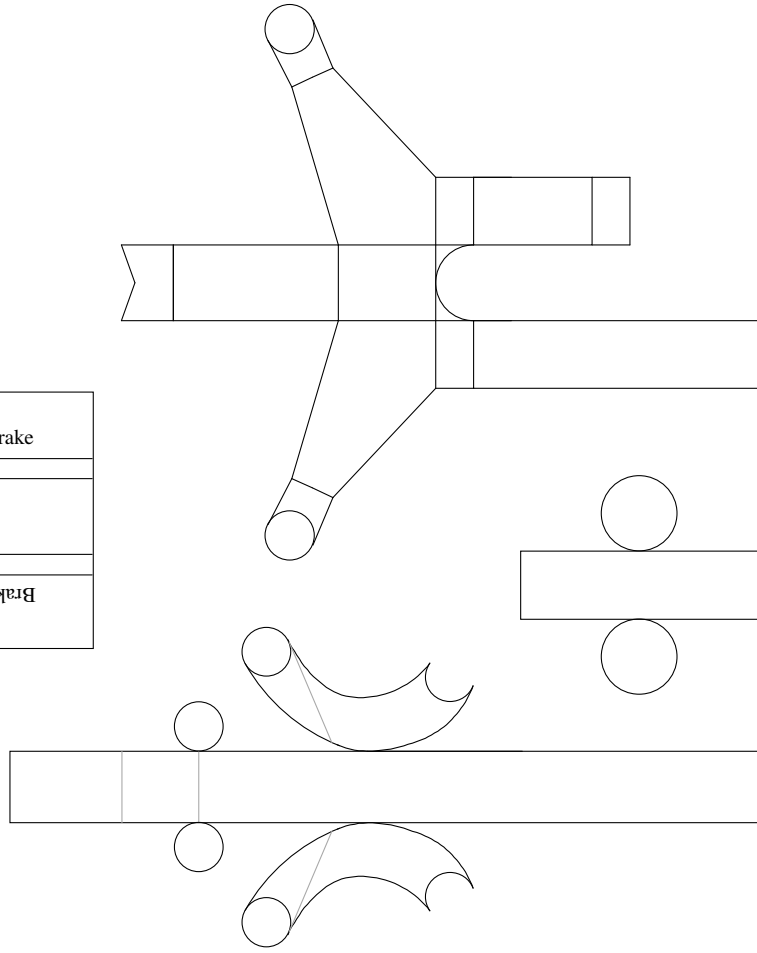
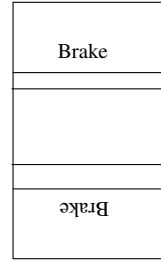

7.50 inches [19.05 cm]

inches

cm

cm

10.00 inches [25.40 cm]

inches

Conncting Hinge

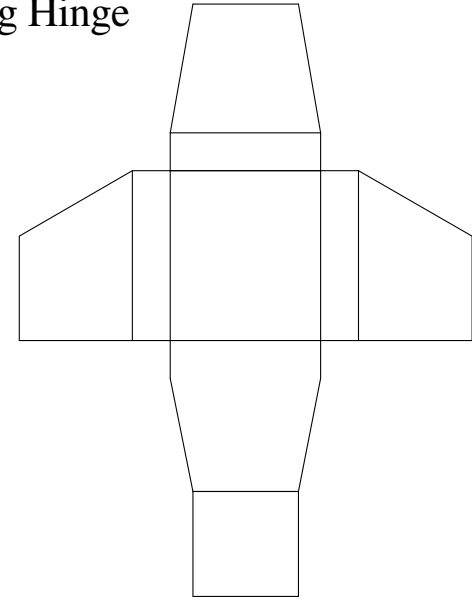

Dropdeck-Middlepart for the center

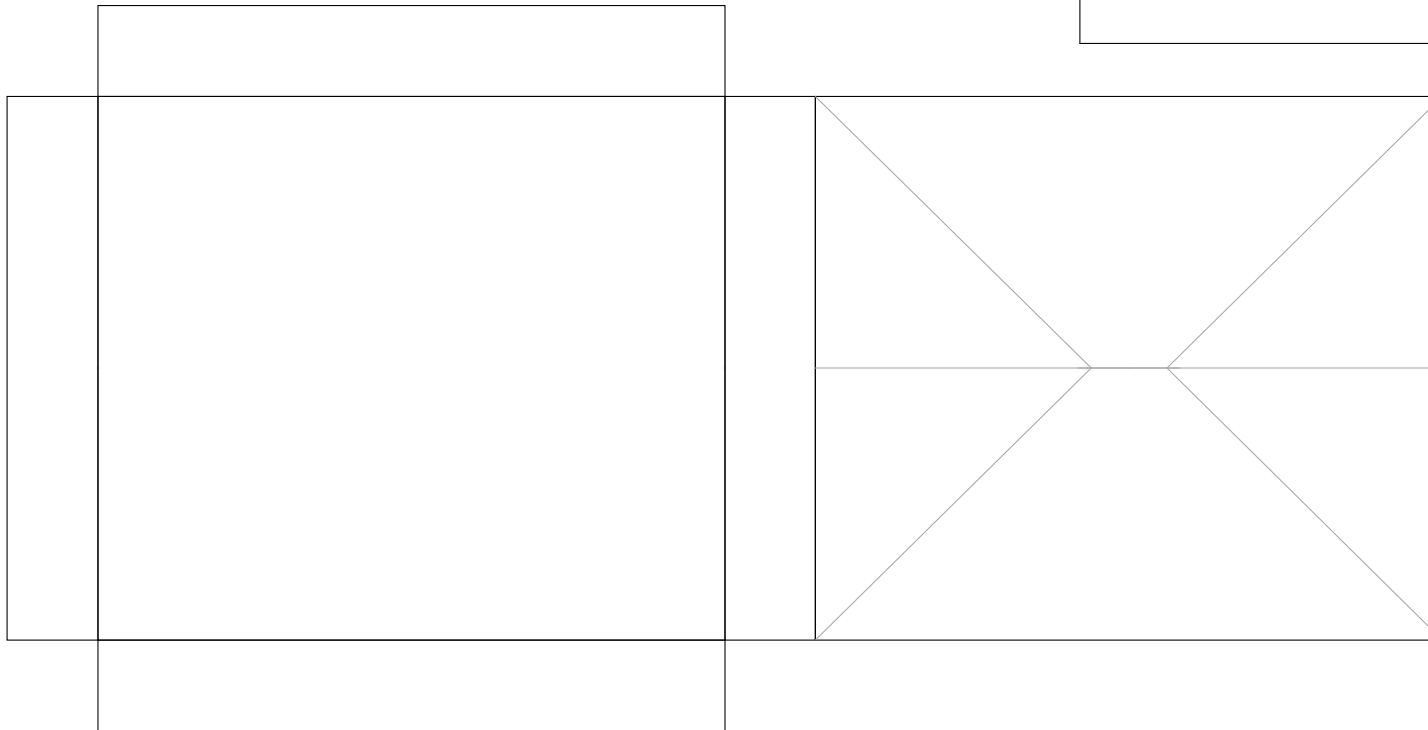

7.50 inches [19.05 cm]

inches

cm

cm

10.00 inches [25.40 cm]

7.50 inches [19.05 cm]

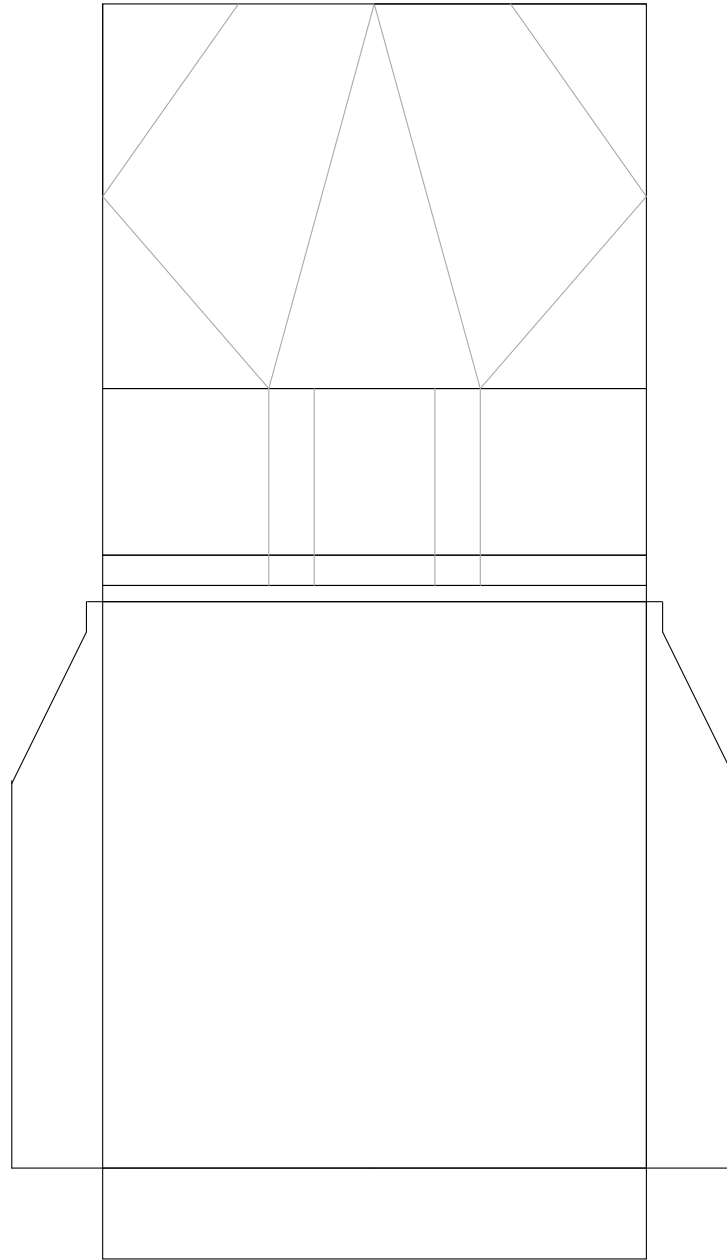
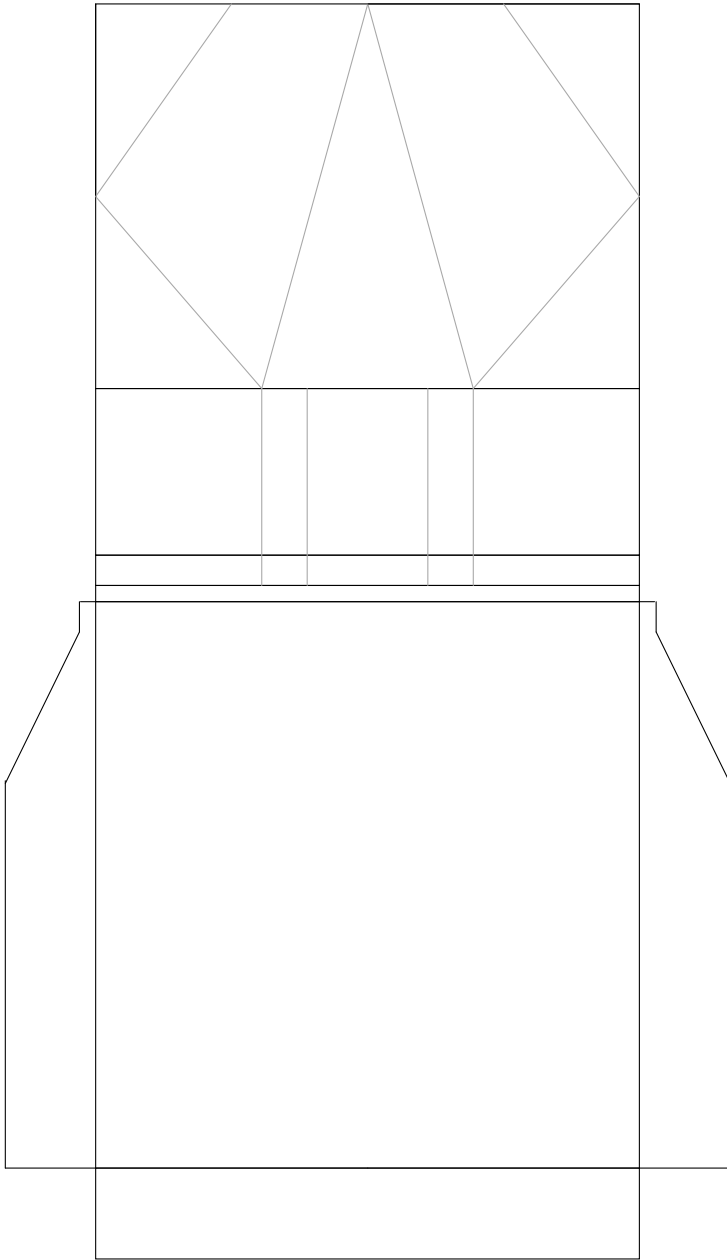

Dropdeck-Endparts

inches

cm

cm

inches

10.00 inches [25.40 cm]

Dropdeck-Middleparts for wheelrecess

7.50 inches [19.05 cm]

inches

cm

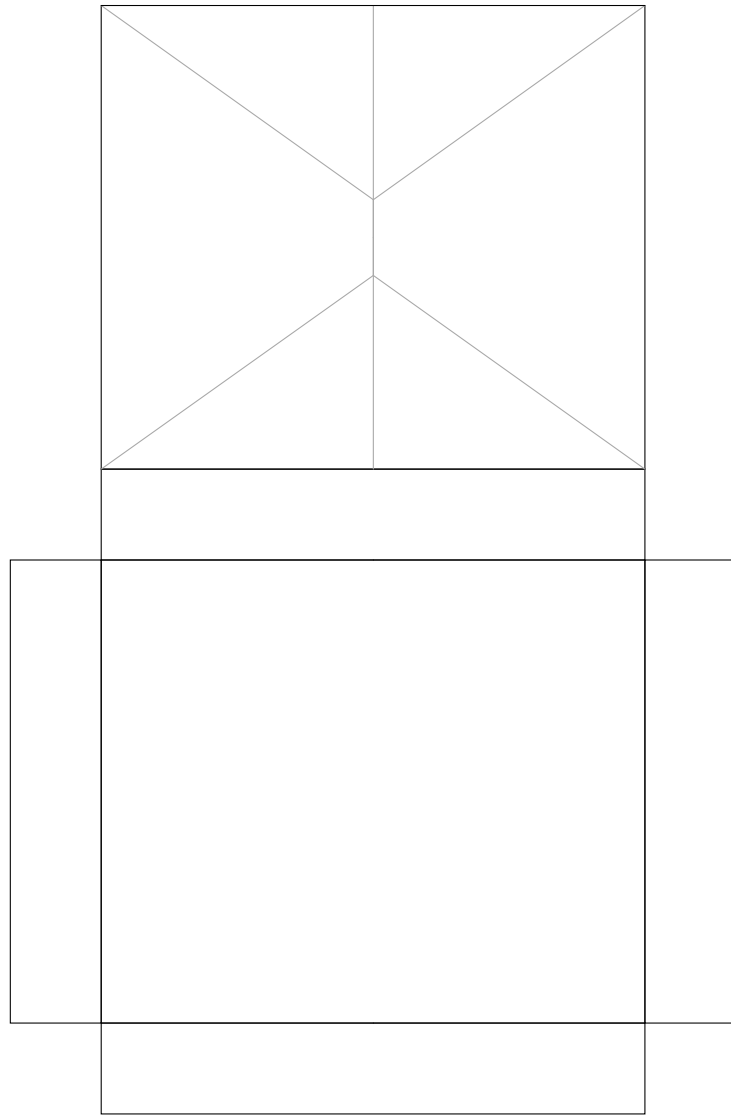
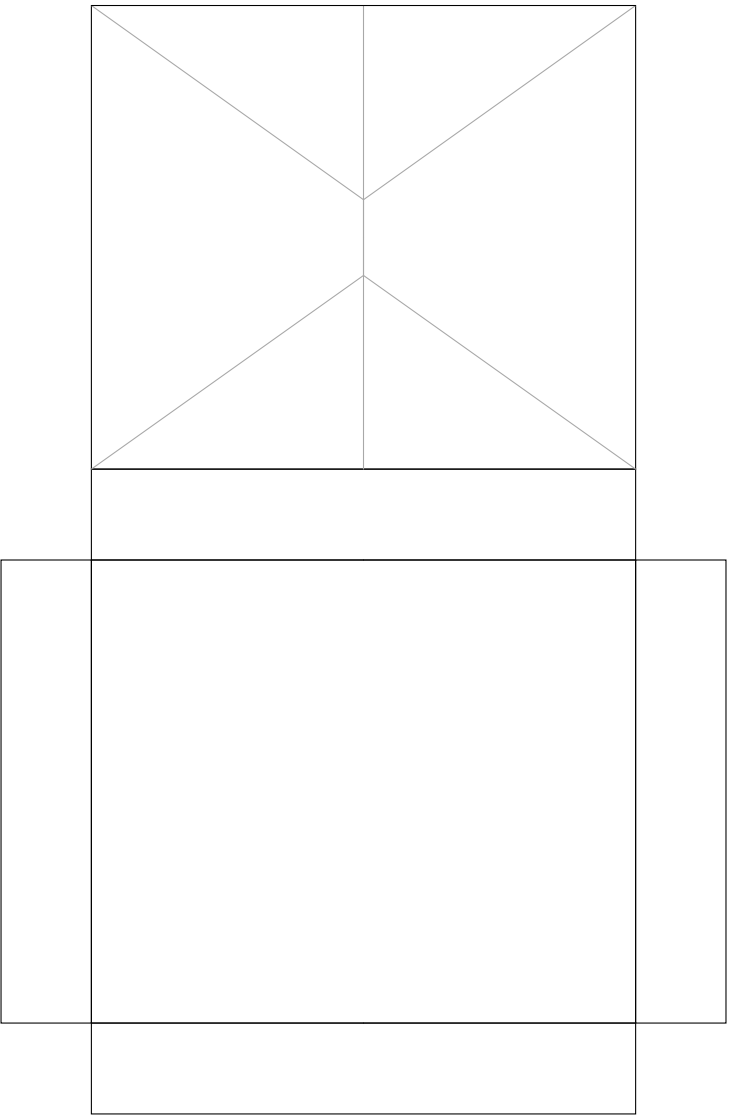

inches

cm

10.00 inches [25.40 cm]

7.50 inches [19.05 cm]

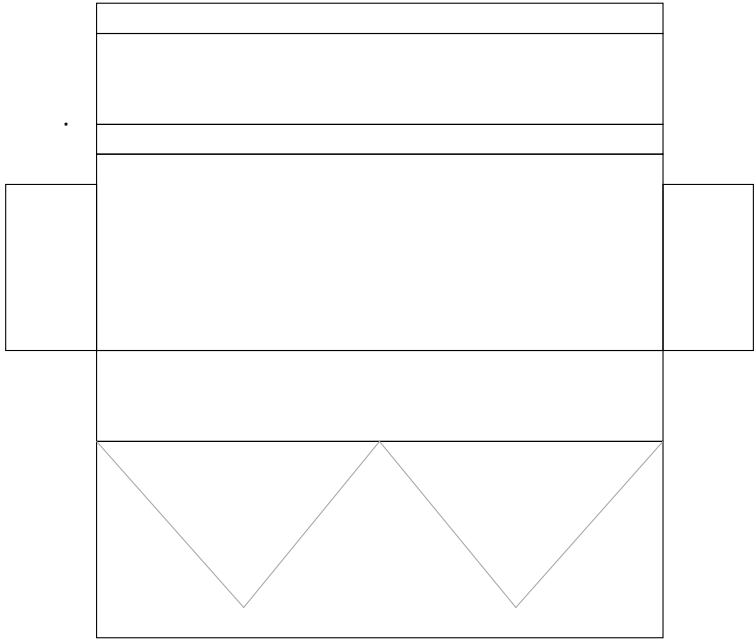
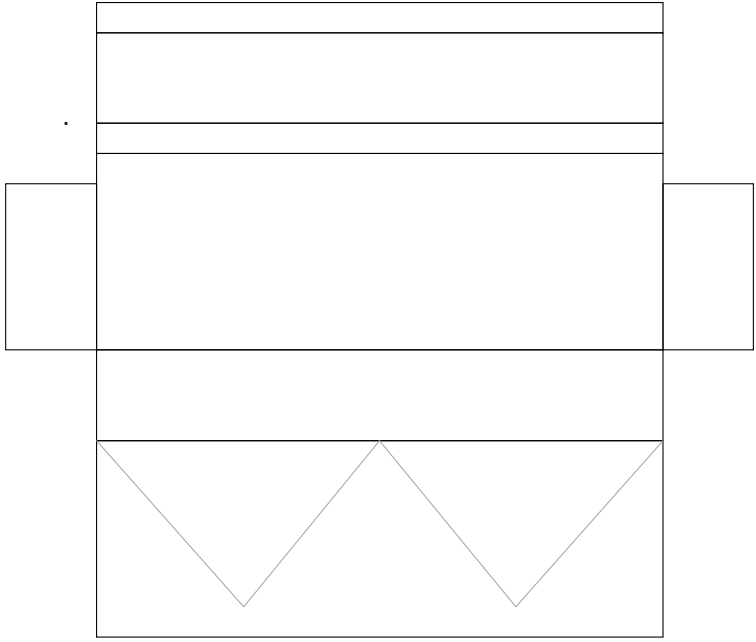

Dropdeck-Sideparts

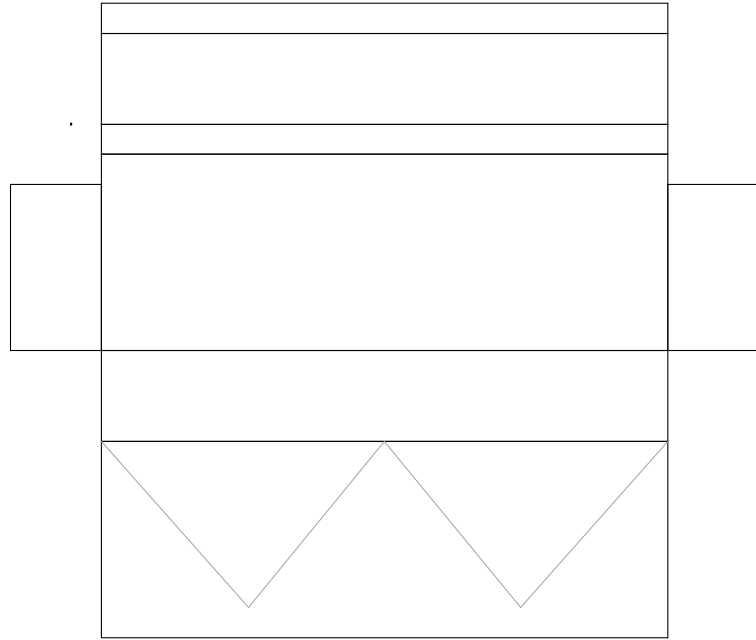
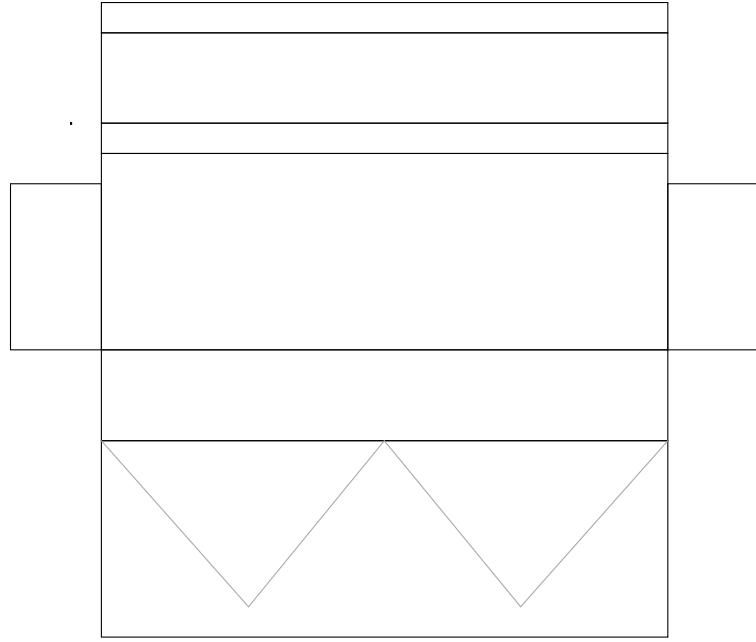

inches

inches

cm

cm

10.00 inches [25.40 cm]

inches

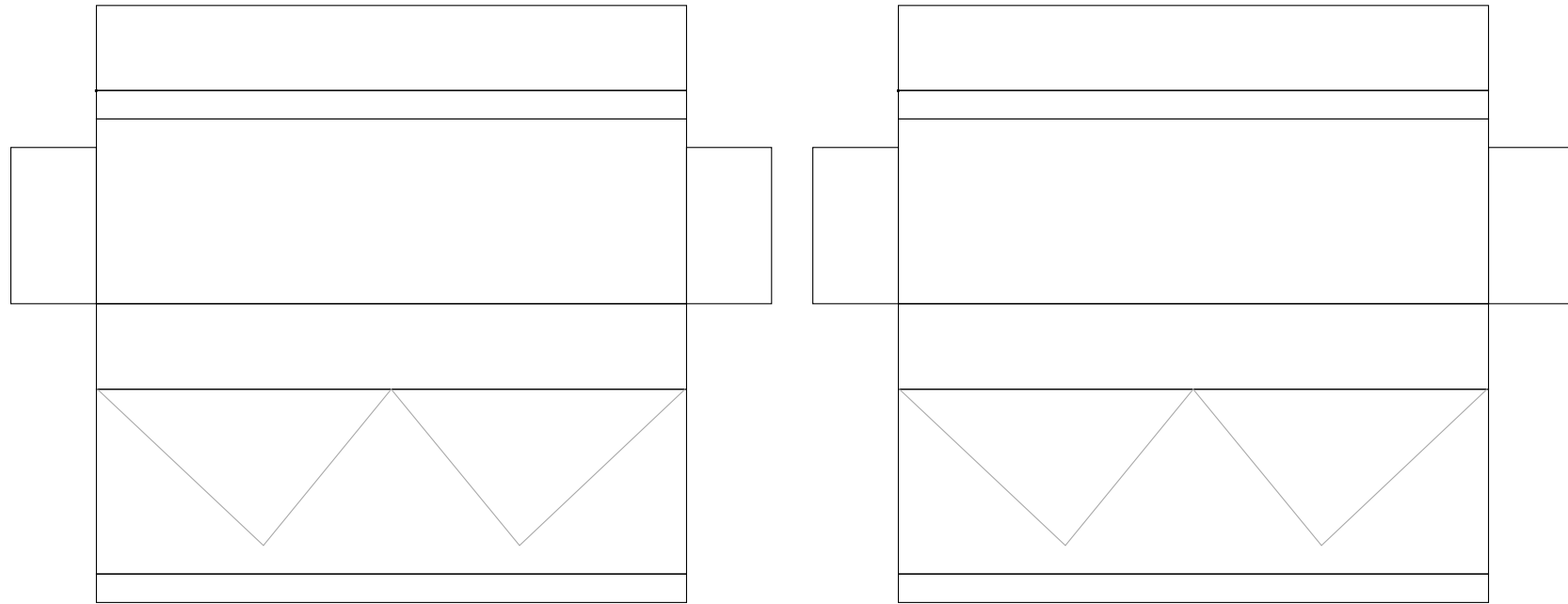

7.50 inches [19.05 cm]

Dropdeck-Sideparts for the center

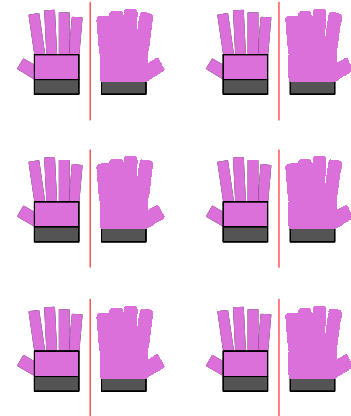
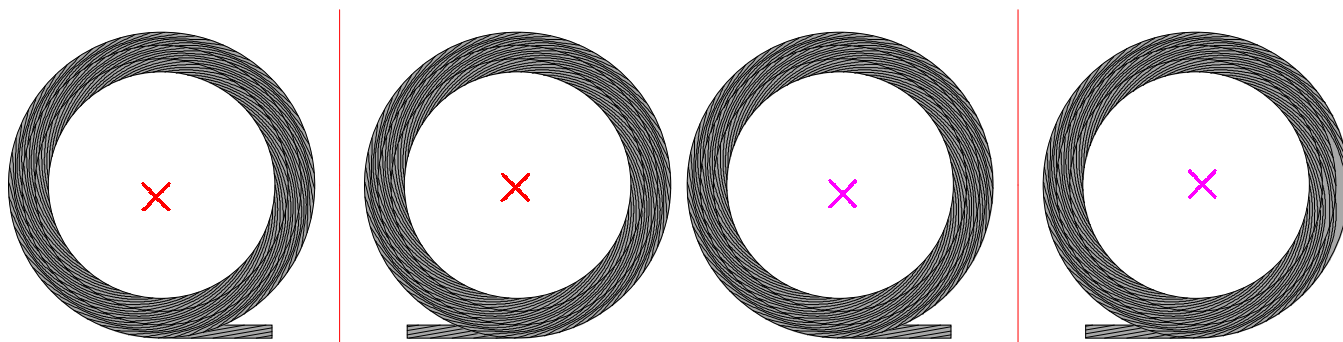
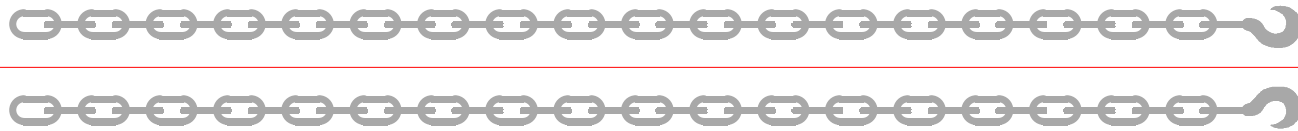

inches

cm

cm

10.00 inches [25.40 cm]

inches

7.50 inches [19.05 cm]

inches

cm

cm

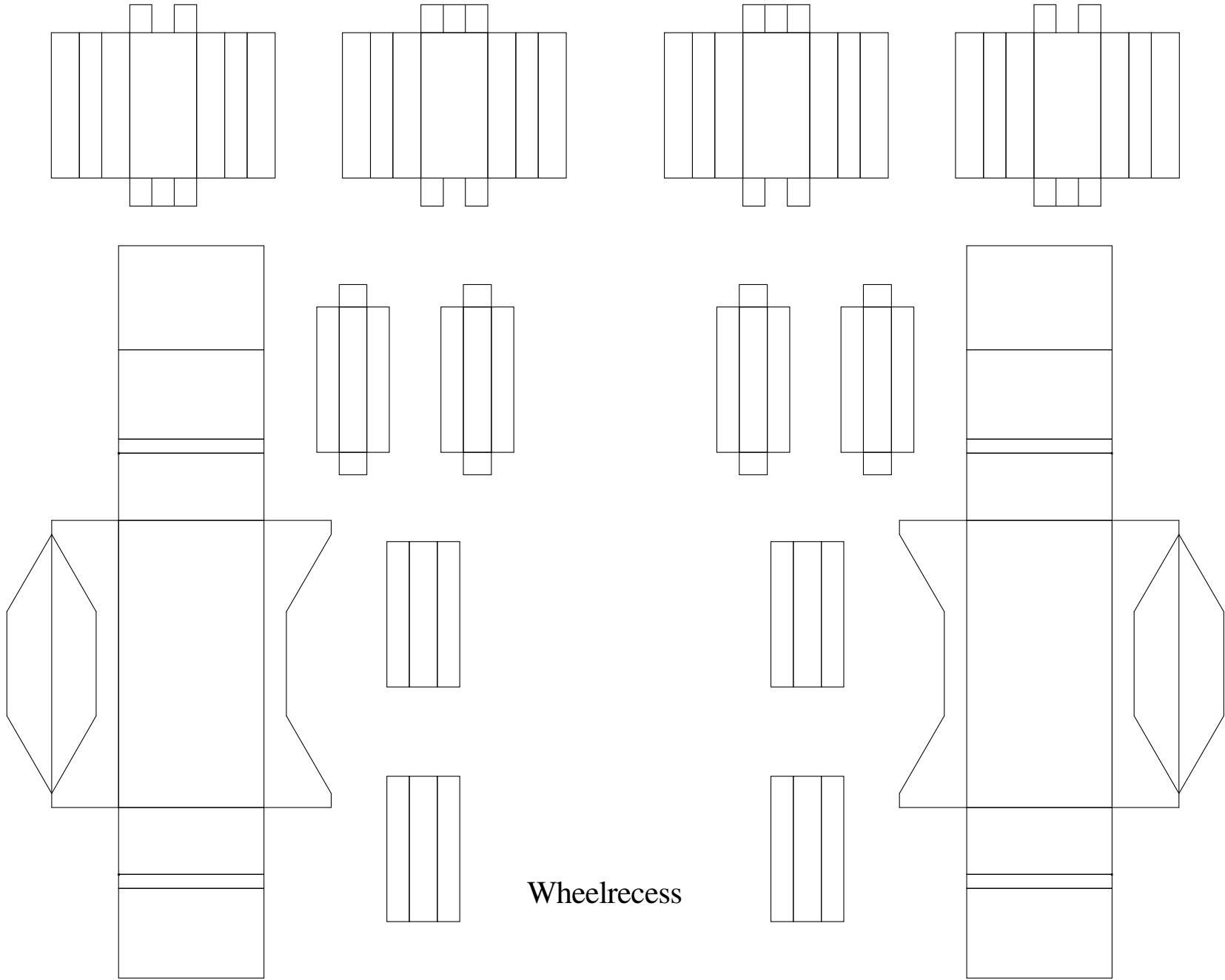

Wheelrecess

10.00 inches [25.40 cm]

7.50 inches [19.05 cm]

inches



Upper Surface

inches

cm

cm

10.00 inches [25.40 cm]

7.50 inches [19.05 cm]

inches

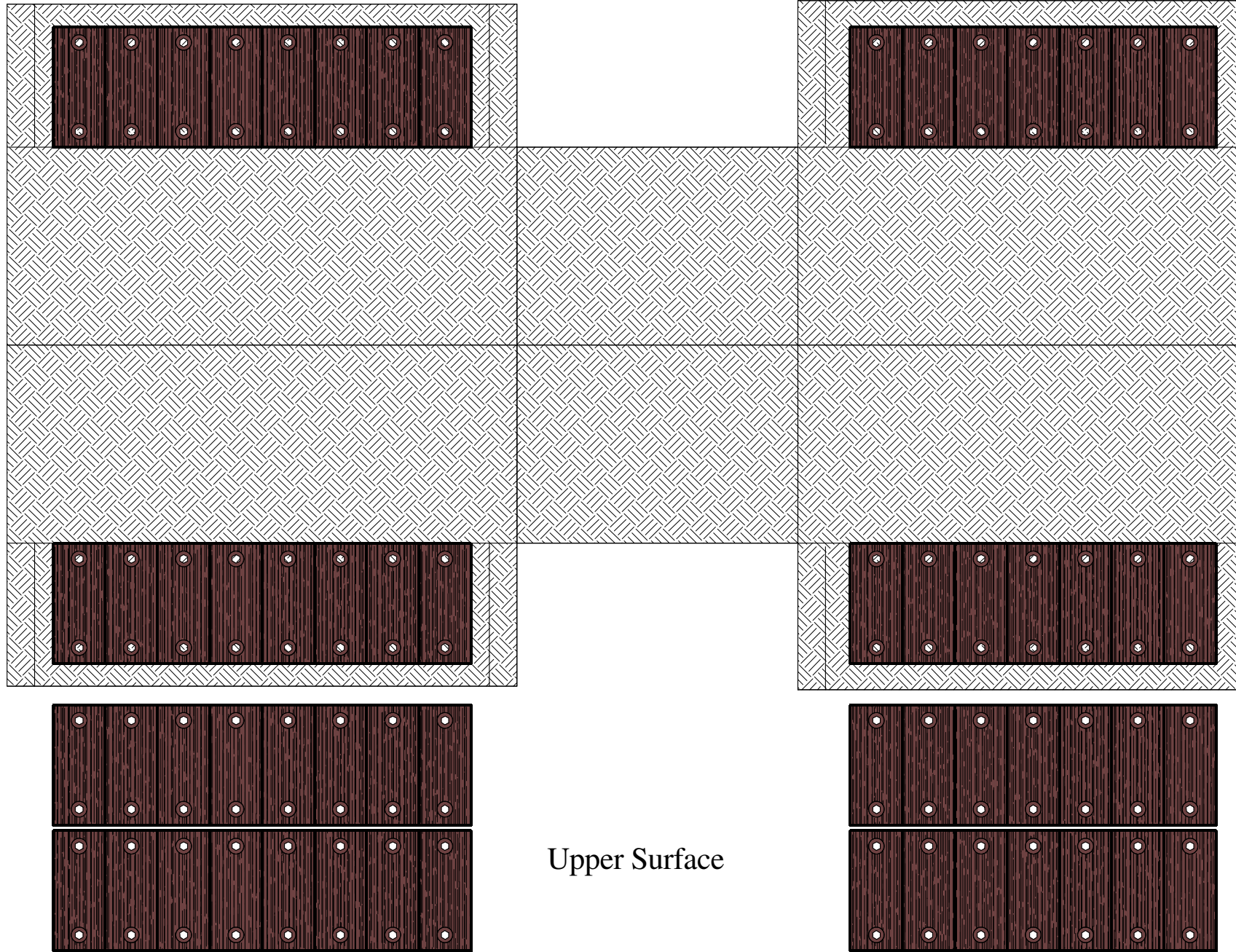

Upper Surface

inches

cm

cm

10.00 inches [25.40 cm]

inches

7.50 inches [19.05 cm]

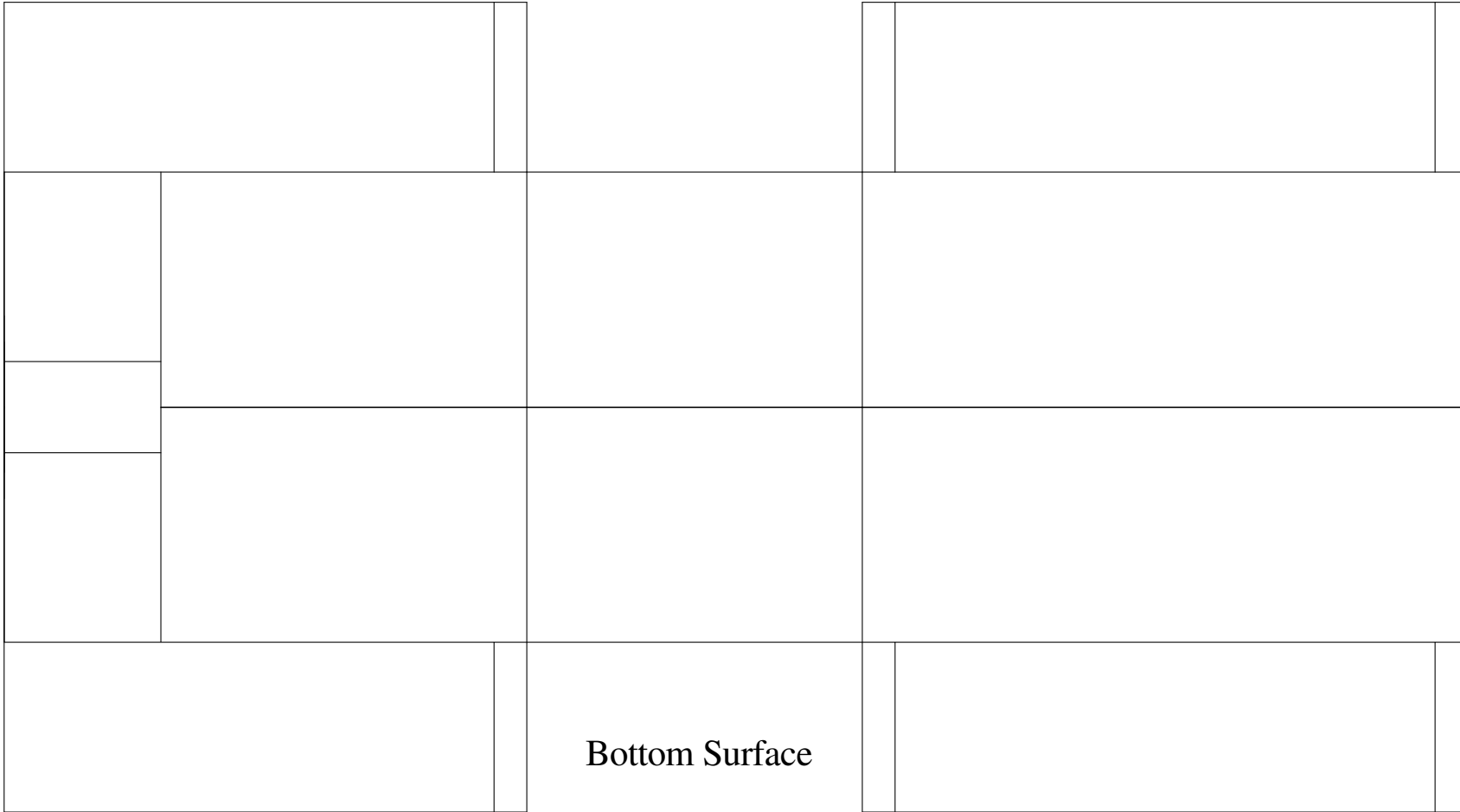

Bottom Surface

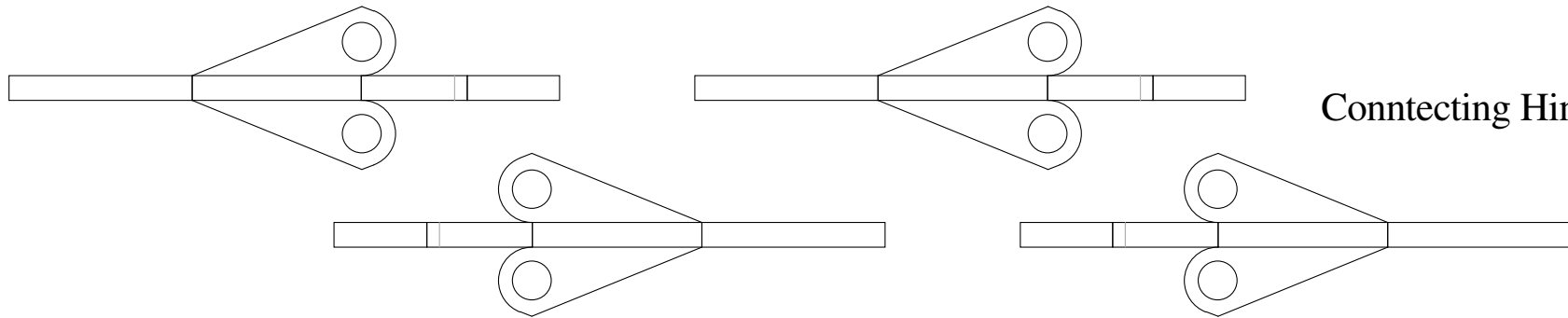

Conncting Hinge

inches

cm

cm

10.00 inches [25.40 cm]

7.50 inches [19.05 cm]

inches

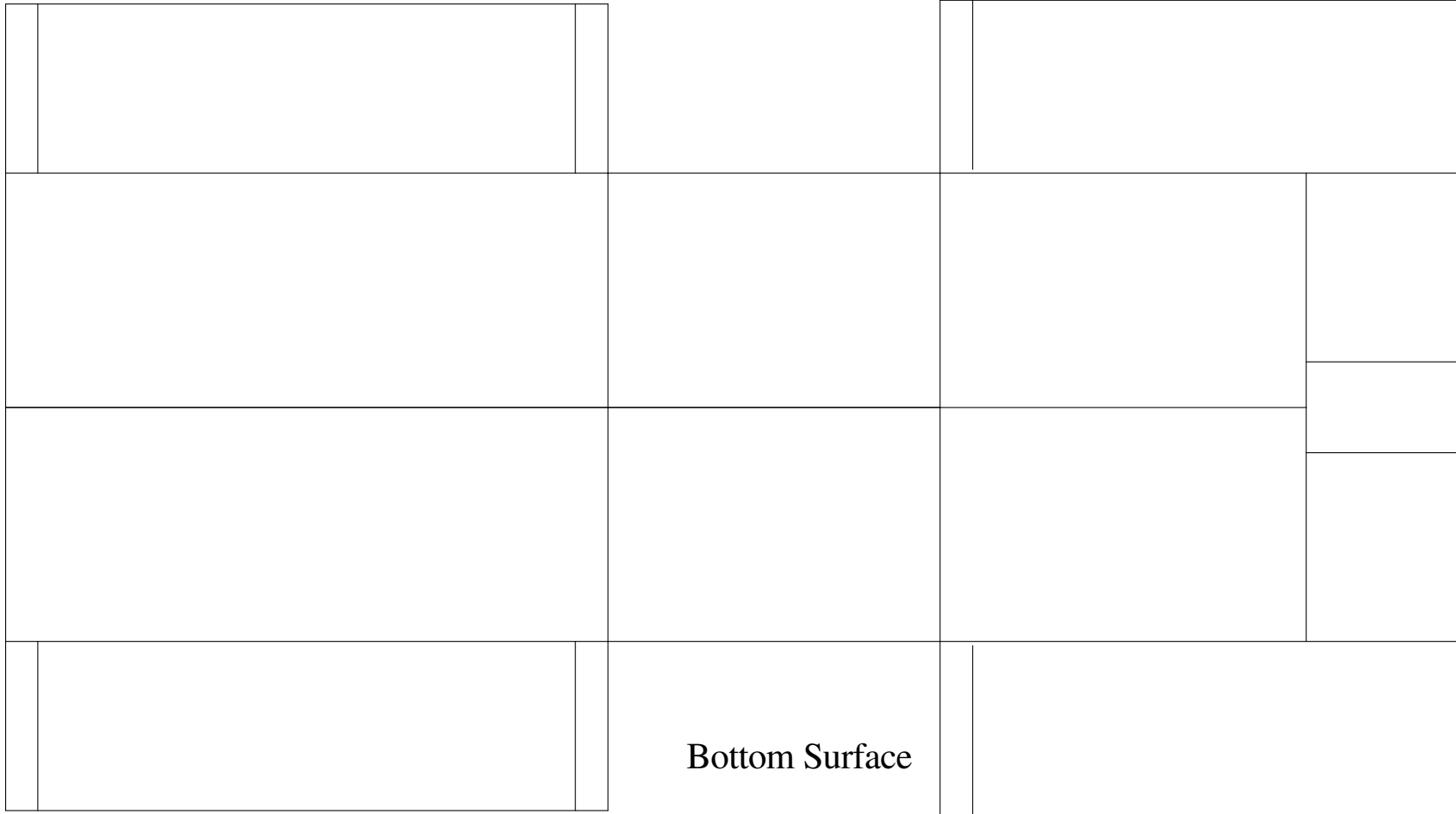

Bottom Surface

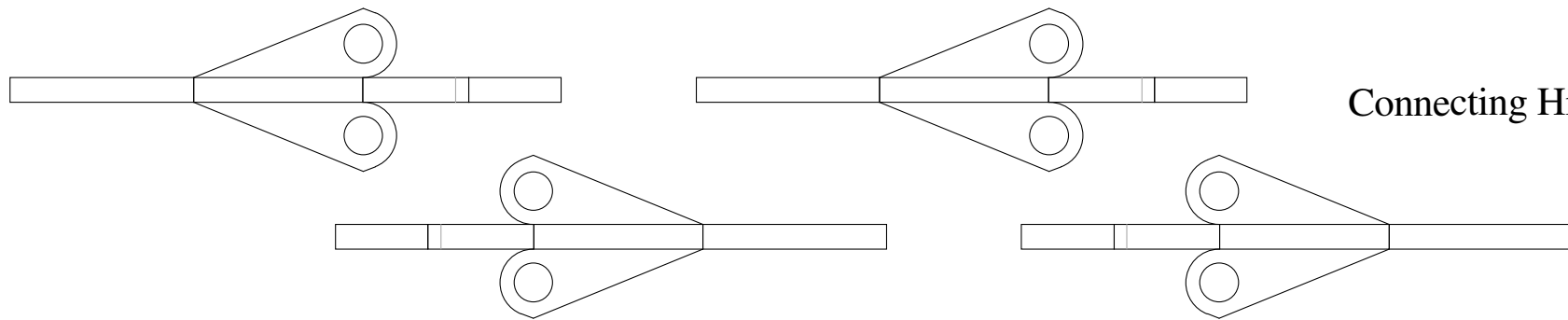

Connecting Hinge

inches

cm

cm

10.00 inches [25.40 cm]

7.50 inches [19.05 cm]

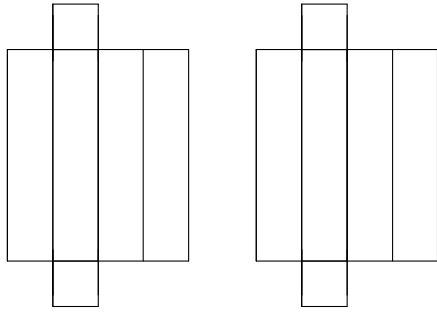
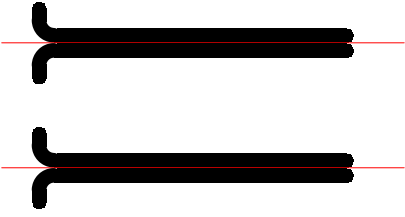
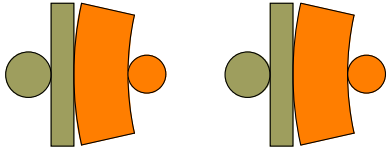

Bumper

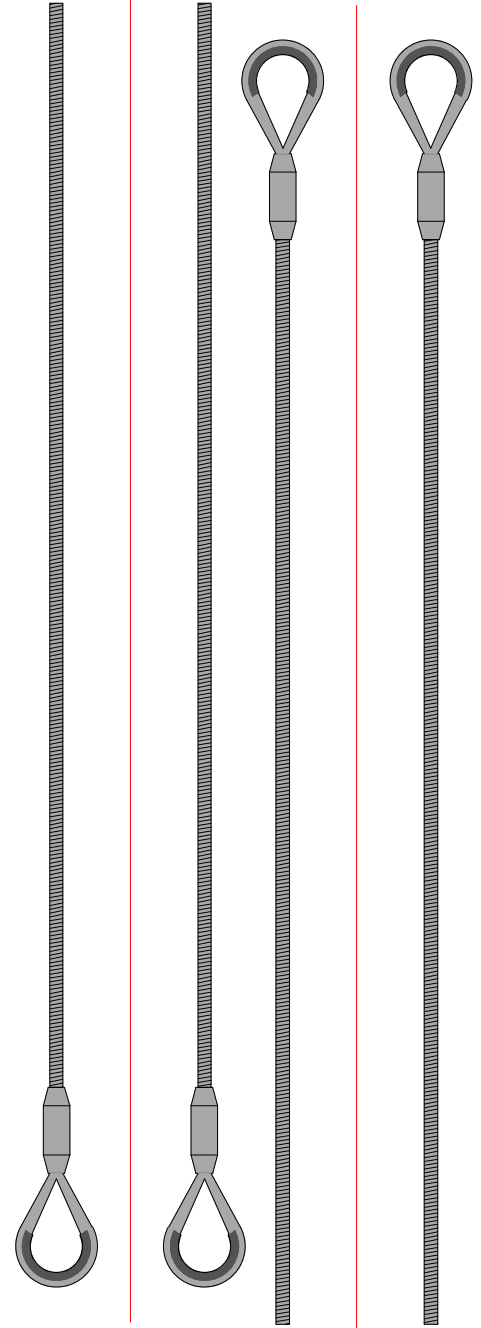
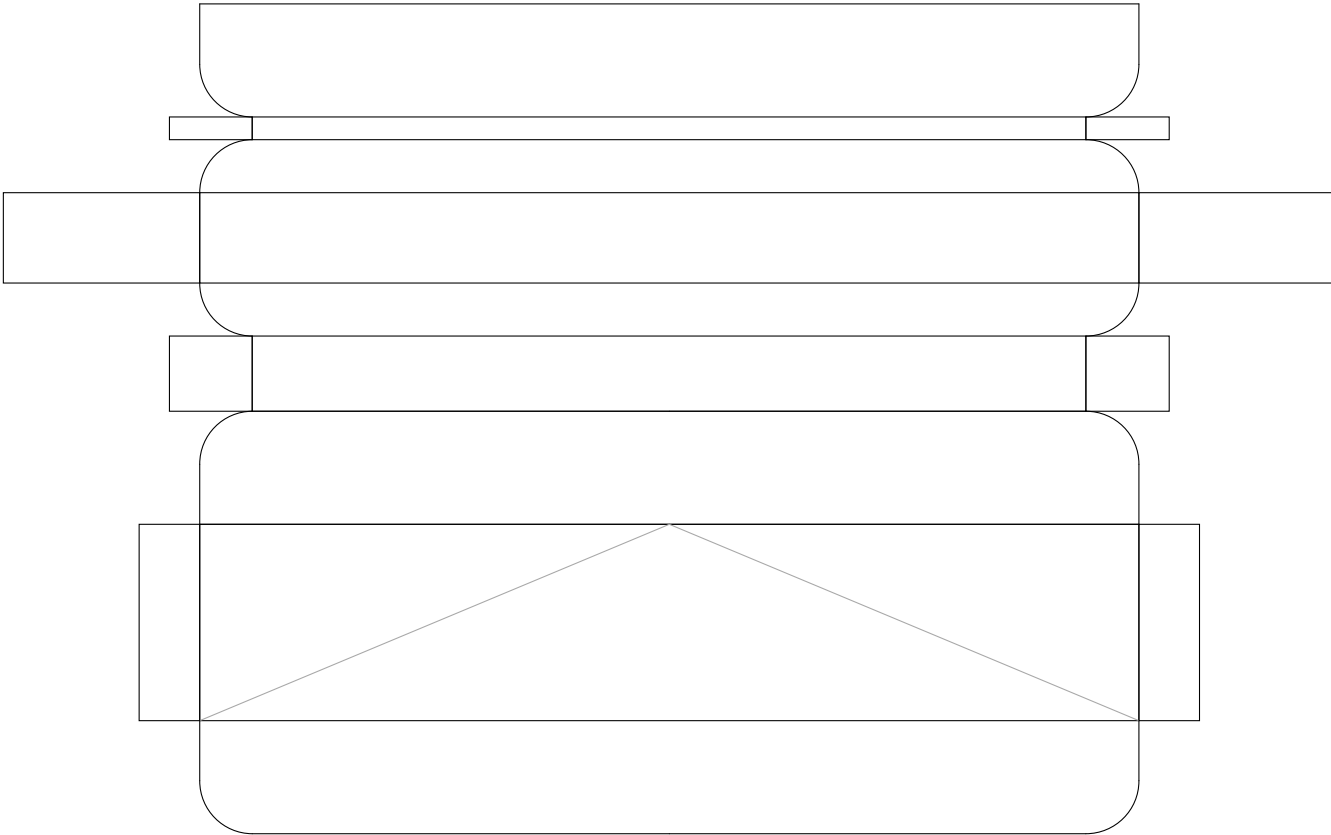

inches

inches

cm

cm

10.00 inches [25.40 cm]

7.50 inches [19.05 cm]

inches

cm

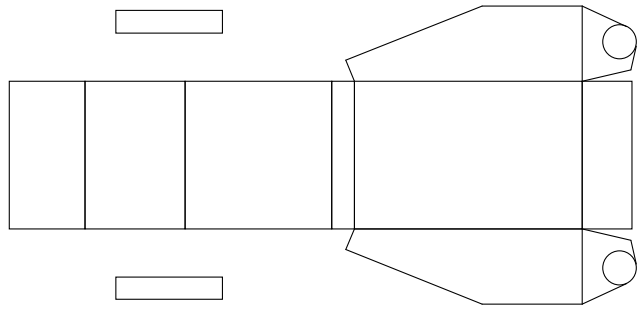

Loadingramp Front

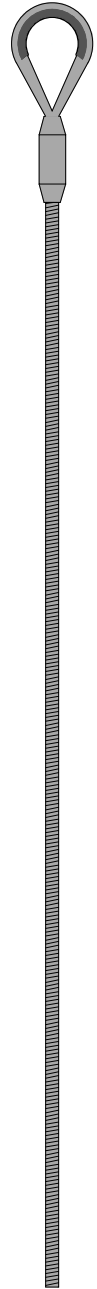
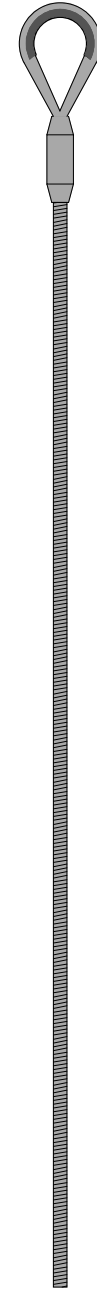
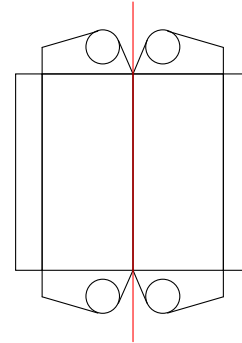
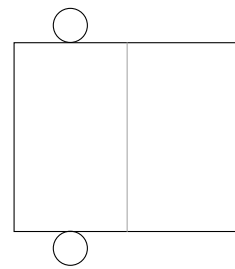
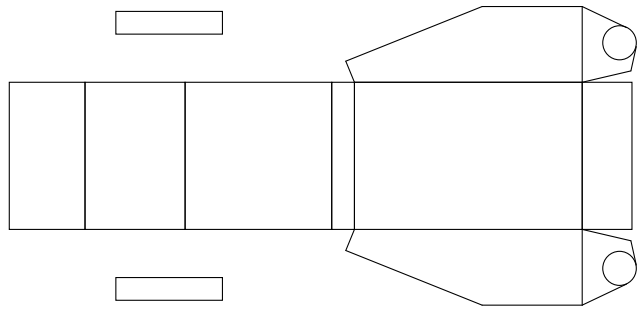
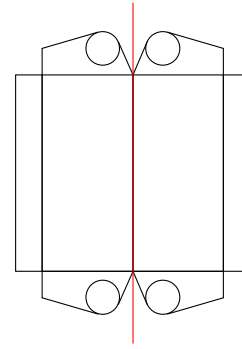
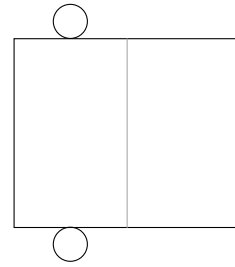

cm

Loadingramp

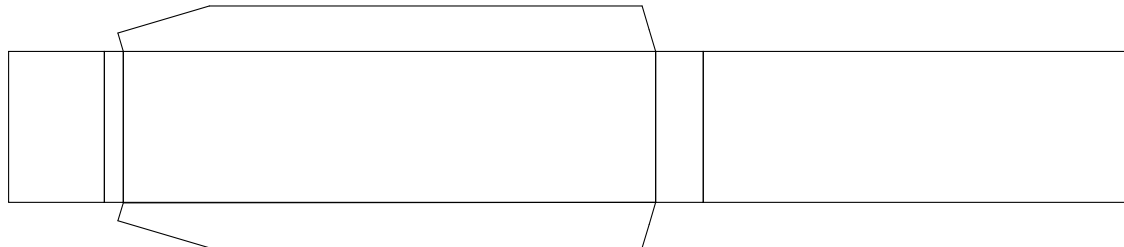
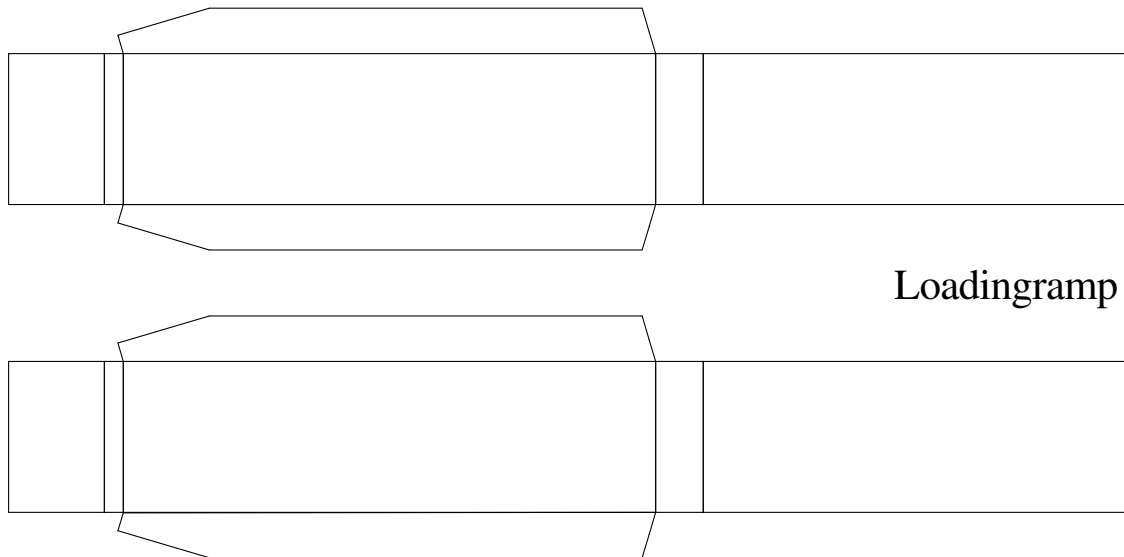

inches

cm

10.00 inches [25.40 cm]

inches

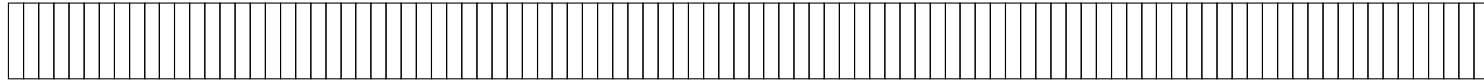
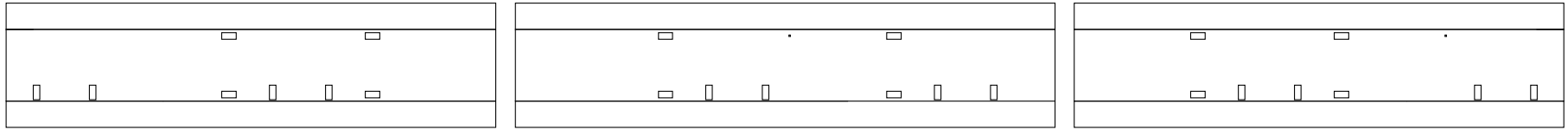

Sideextensions

7.50 inches [19.05 cm]

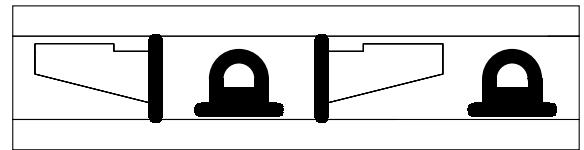
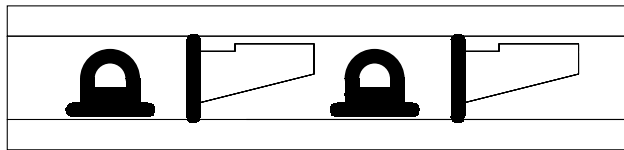
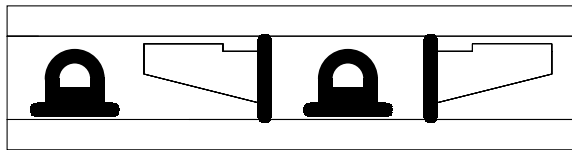
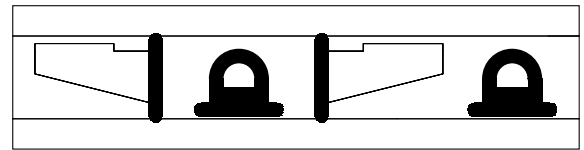
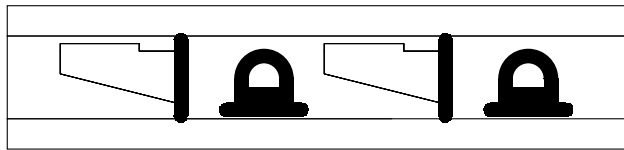
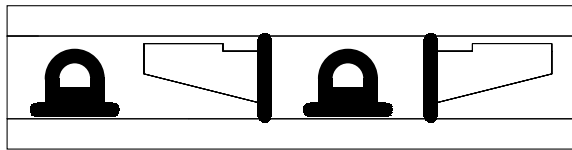
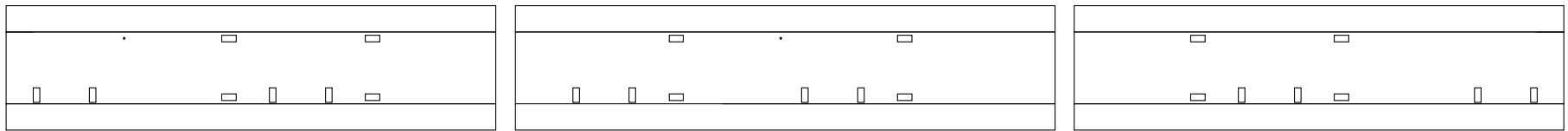
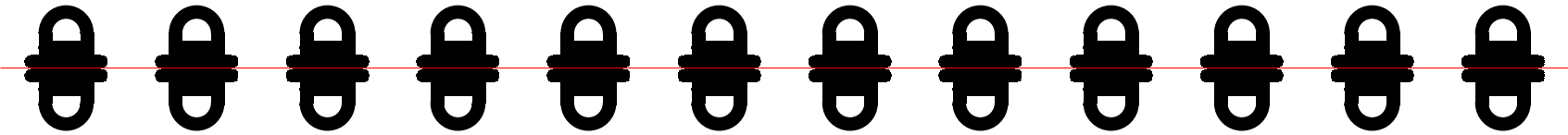
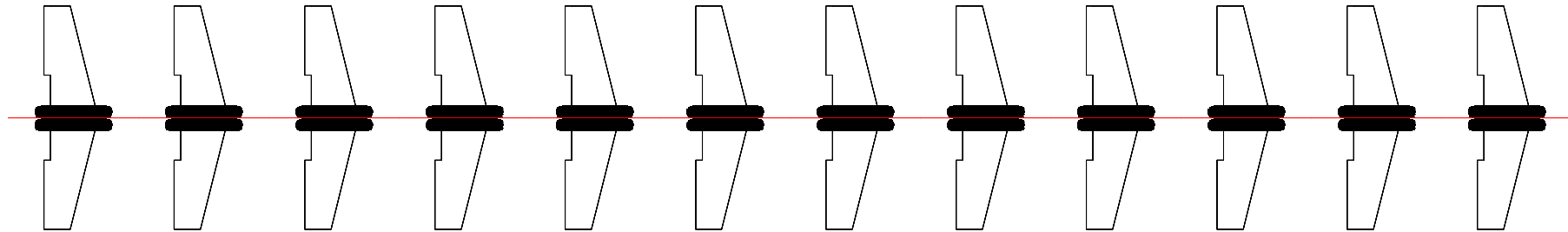

inches

cm

cm

10.00 inches [25.40 cm]

7.50 inches [19.05 cm]

inches

cm

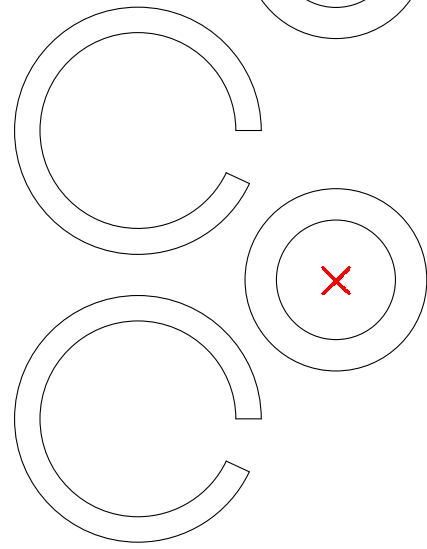
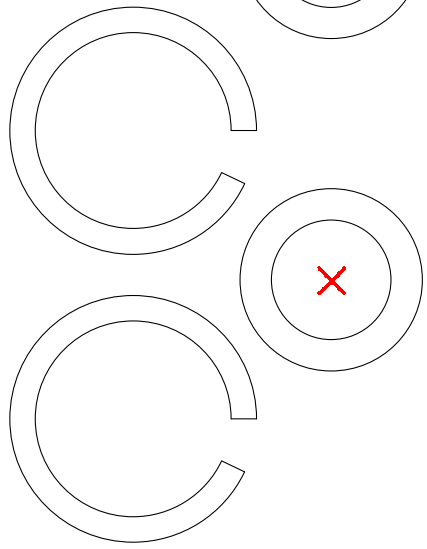
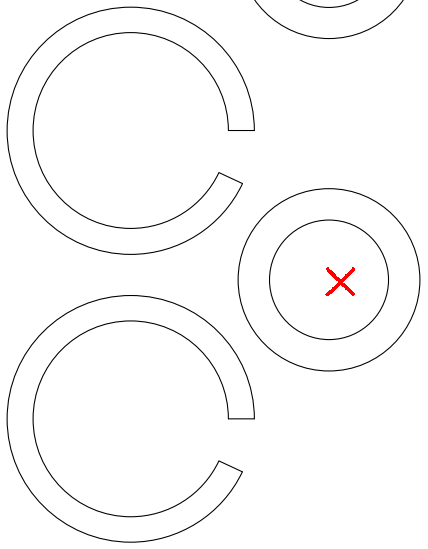
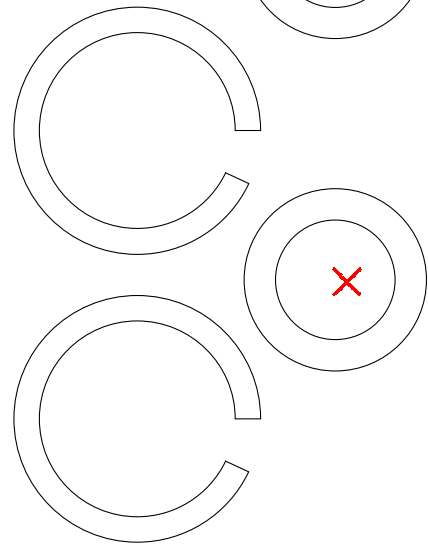
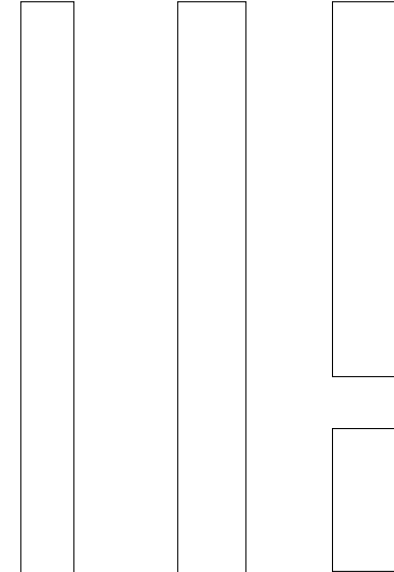
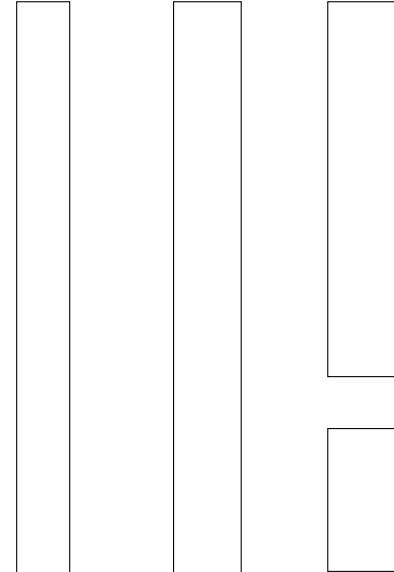
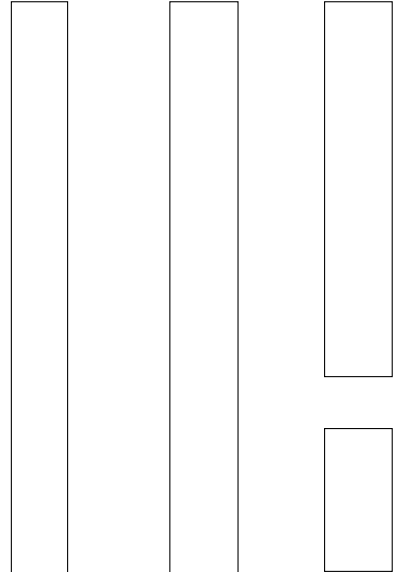
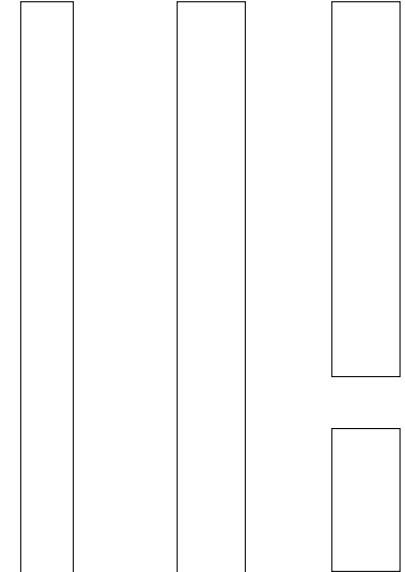

Wheels

inches

cm

10.00 inches [25.40 cm]

inches

Axlcarrier



7.50 inches [19.05 cm]

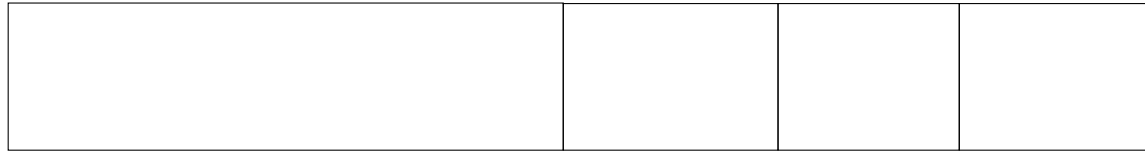

Gooseneck outside

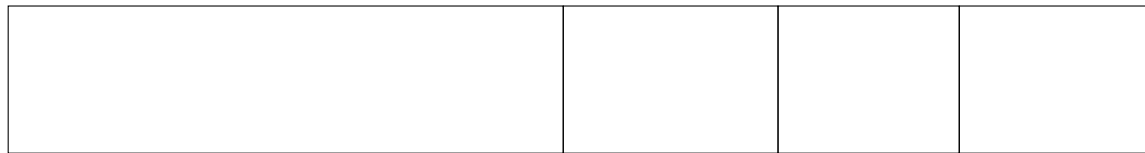

inches

cm

cm

10.00 inches [25.40 cm]

inches

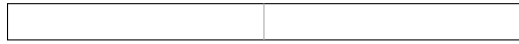

Gooseneck

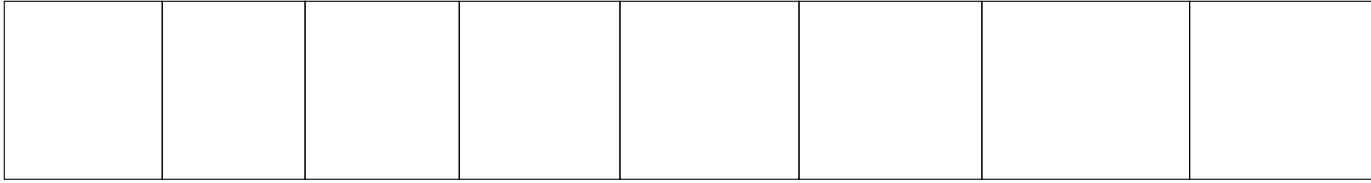
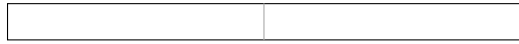

Gooseneck

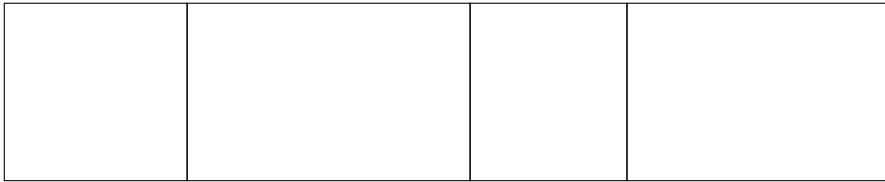

7.50 inches [19.05 cm]

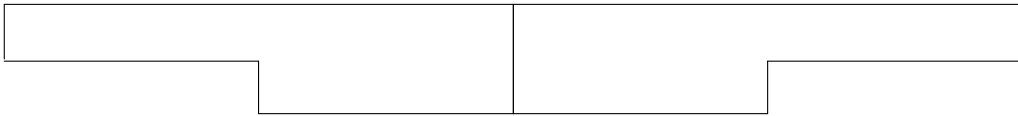

Bumper

inches

cm

cm

10.00 inches [25.40 cm]

inches

Dropdeck-Middleparts

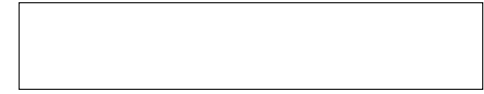
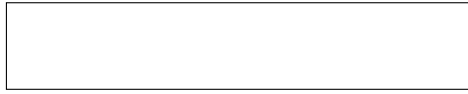

Dropdeck-Endparts

7.50 inches [19.05 cm]

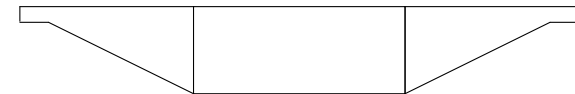
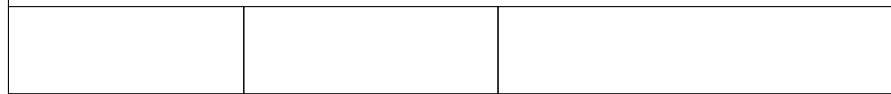
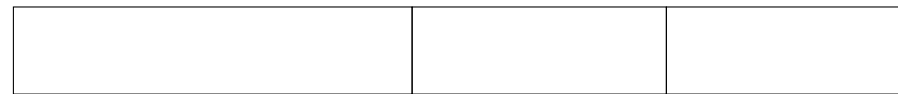
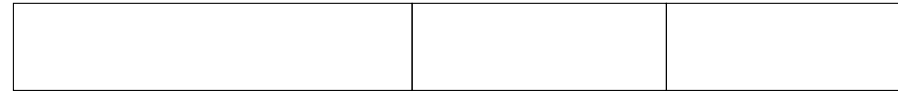
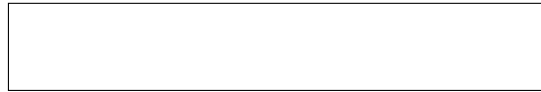

inches

cm

cm

10.00 inches [25.40 cm]

inches



Dropdeck-Middlepart for the center

7.50 inches [19.05 cm]

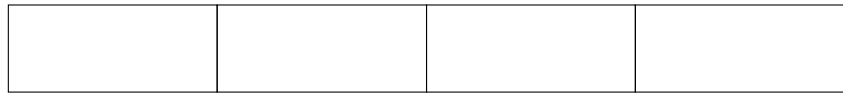
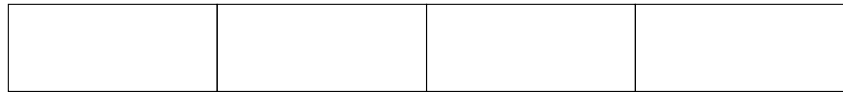

Dropdeck-Sideparts

Dropdeck-Sideparts for the center

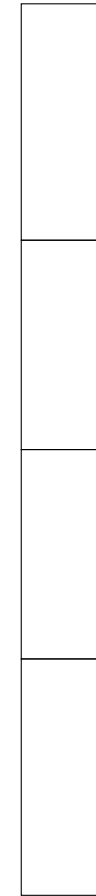
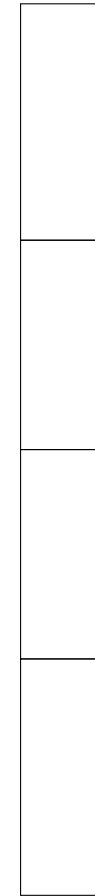

inches

cm

cm

10.00 inches [25.40 cm]

inches

ca. 3mm thick
cardboard

Axlecarrier

7.50 inches [19.05 cm]

ca. 3mm thick
cardboard

Loadingplatform

inches

cm

cm

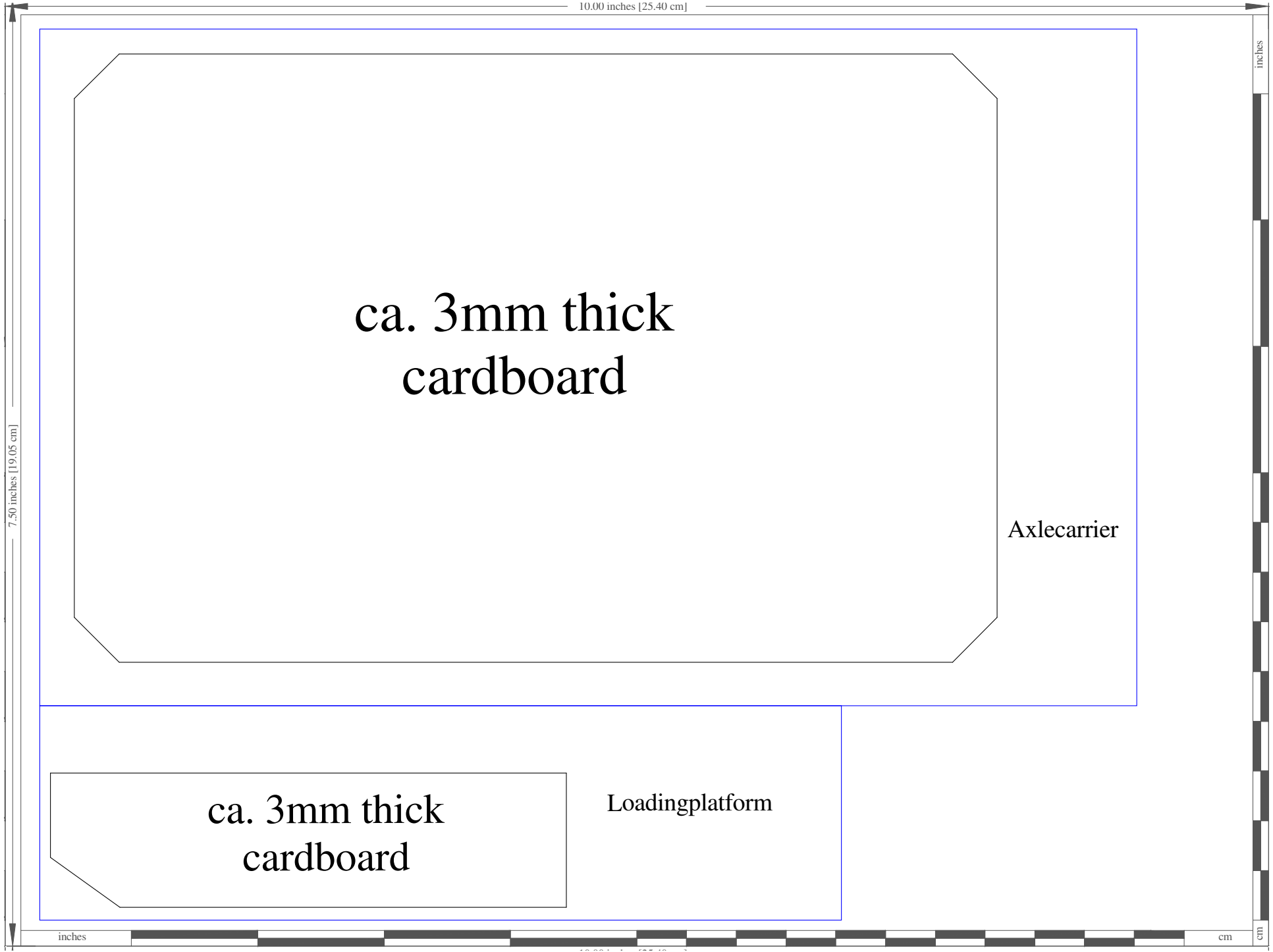



This area have to be cut out



This parts are internal structure



This parts are templates

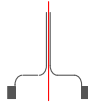

Fold and glue backside



Helpline [folding, guide, cut]

Pages Instruction : 14

Pages Modell : 30

Print Pages 10 3 times

16 2 times

24 6 times

Parts ~ 400

For question, comments, critic send a mail to chriess@vr-web.de