

Apollo / Saturn V
 Scale 1:48 © Greelt A. Peterusma
 J2 Engine Part 1
 Print on 160 - 180 grams paper

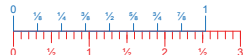

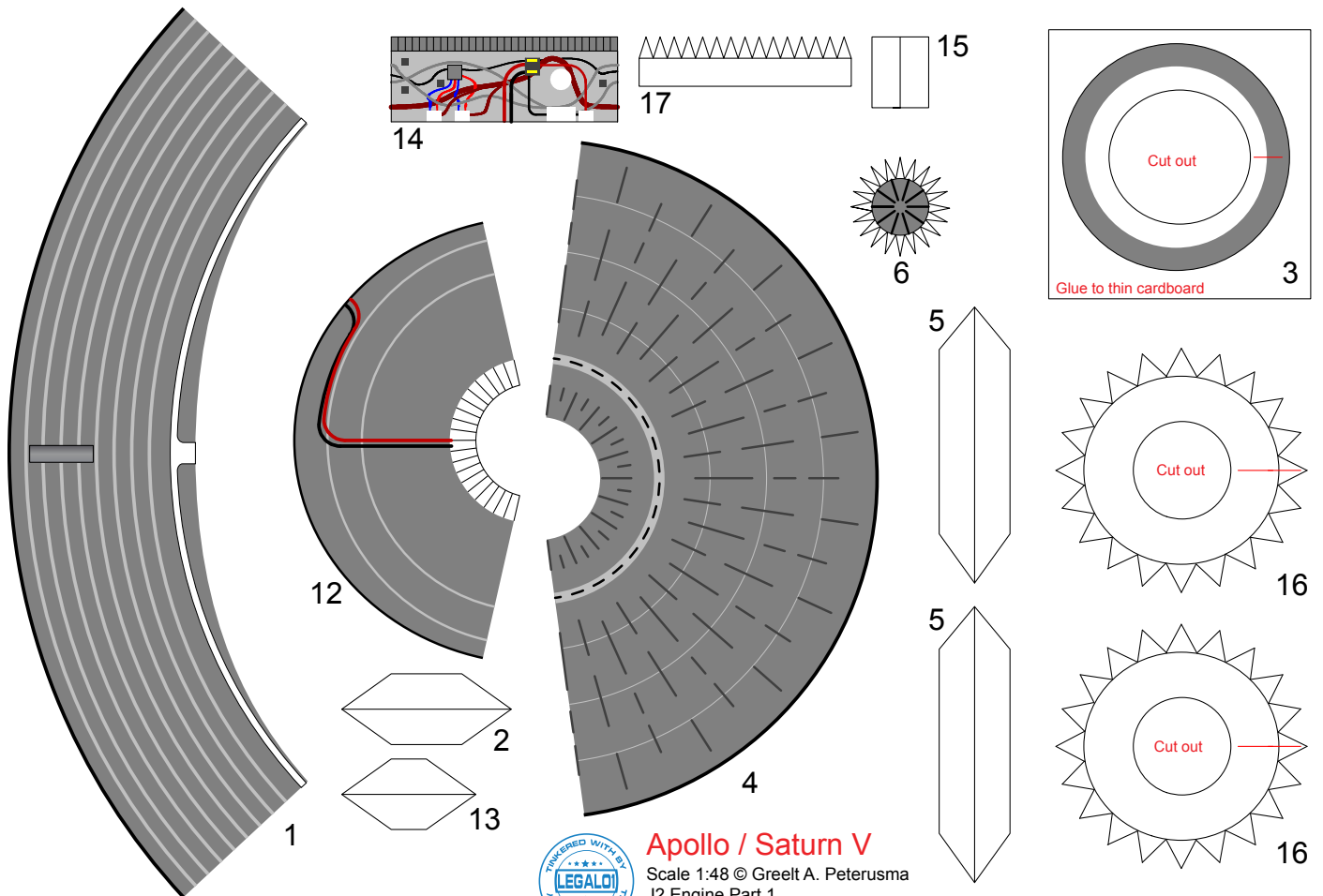
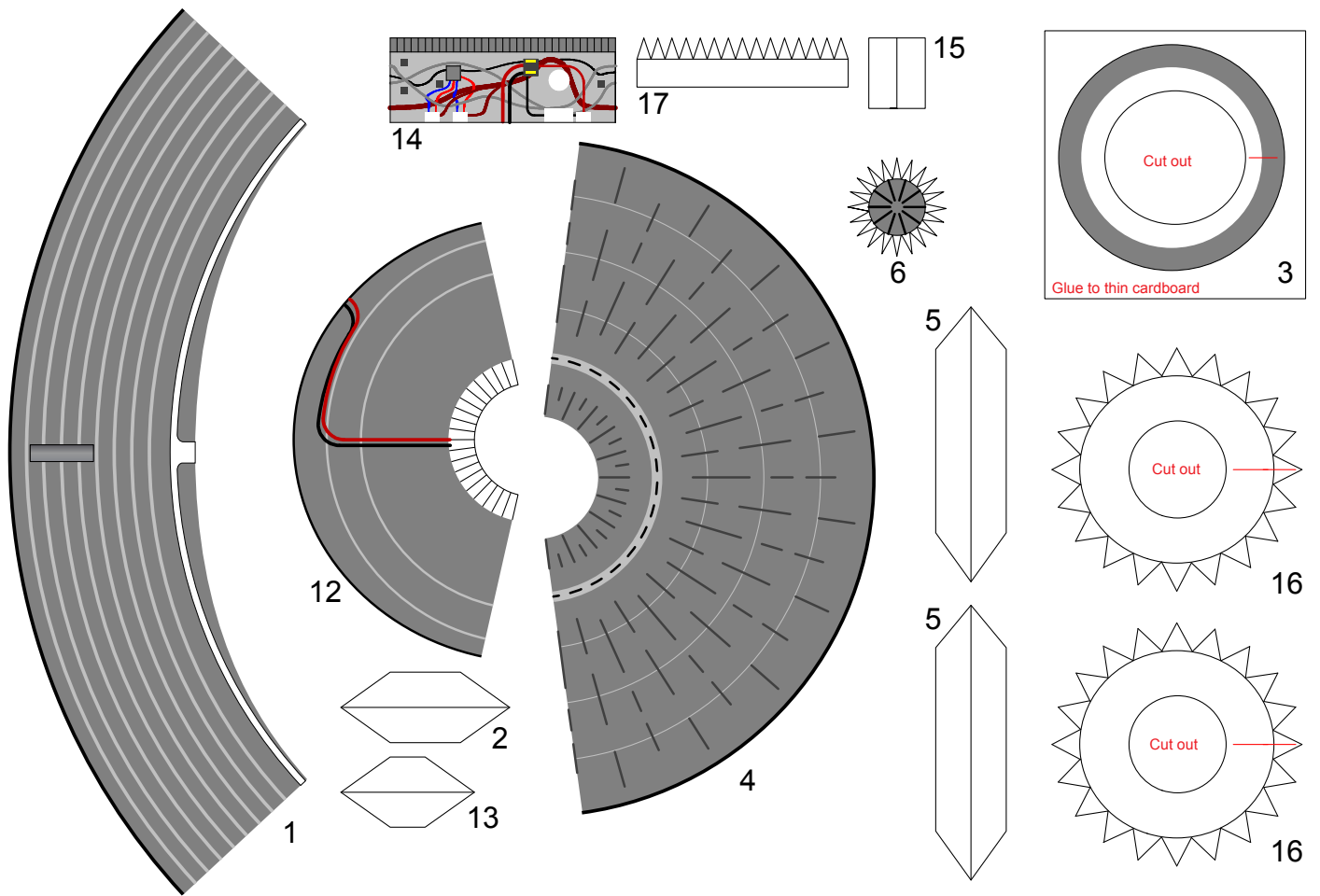

Apollo / Saturn V

Scale 1:48 © Greelt A. Peterusma
 J2 Engine Part 1
 Print on 160 - 180 grams paper

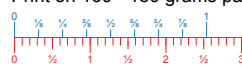

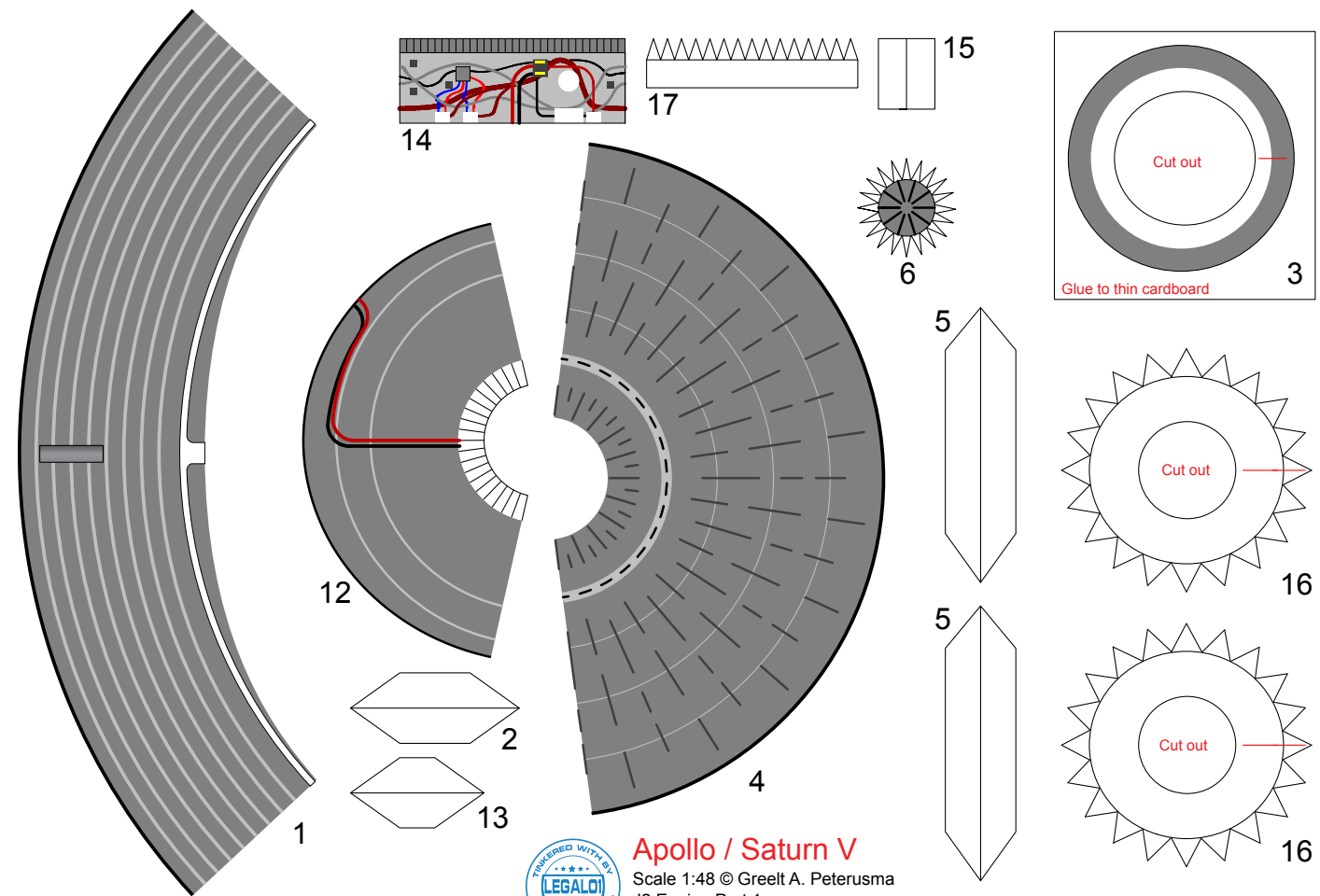
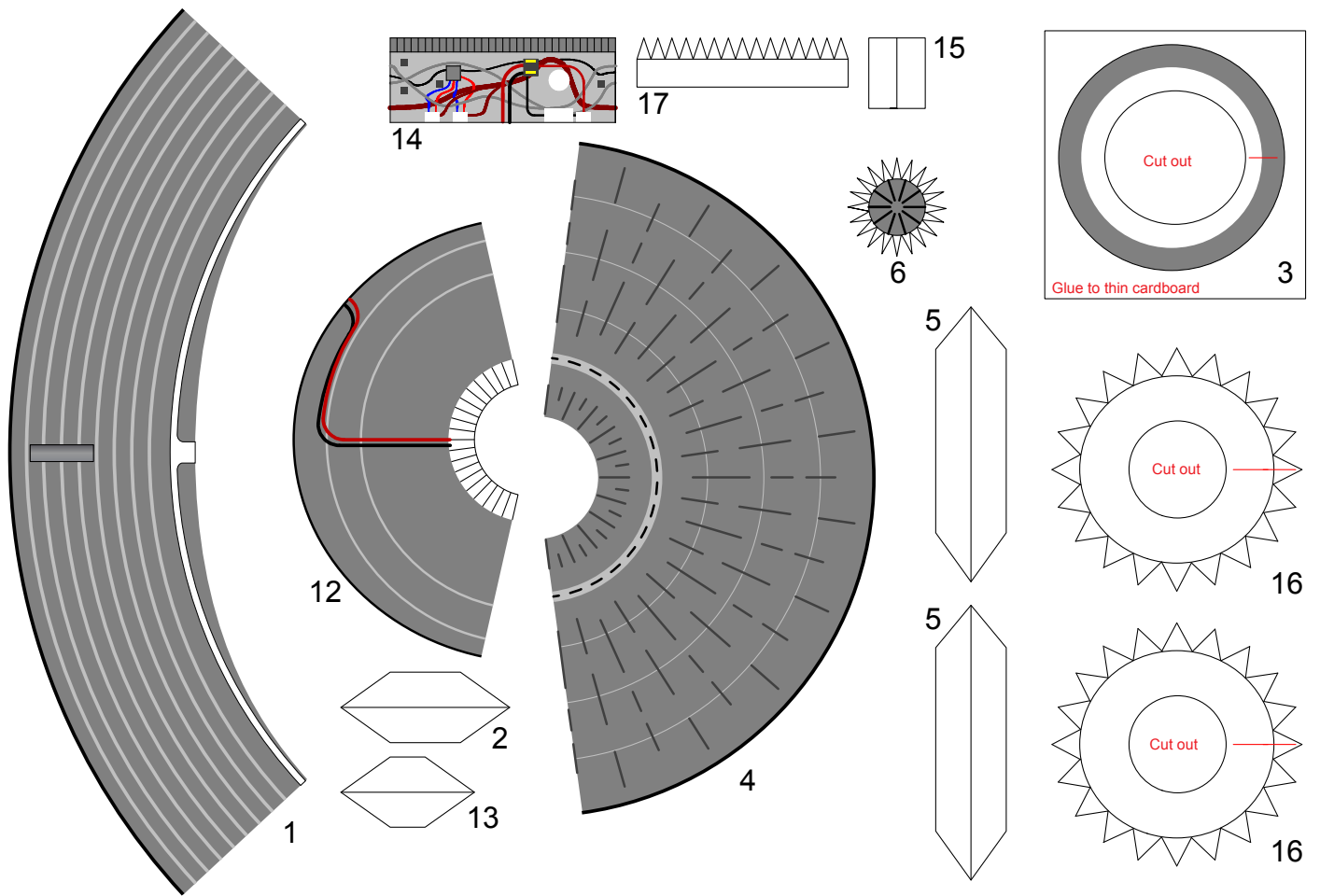

Apollo / Saturn V
 Scale 1:48 © Greelt A. Peterusma
 J2 Engine Part 1
 Print on 160 - 180 grams paper

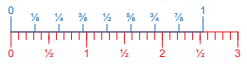

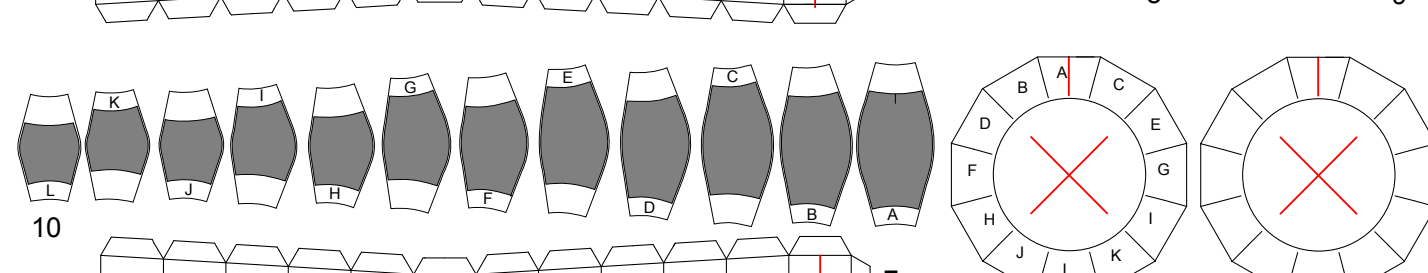
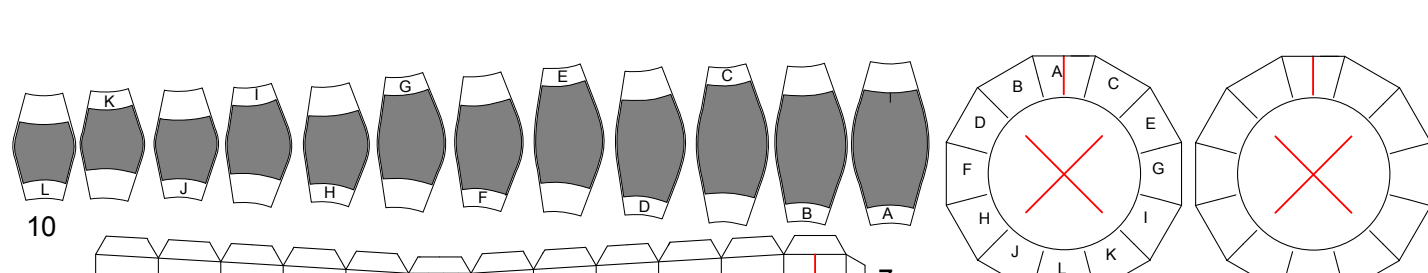
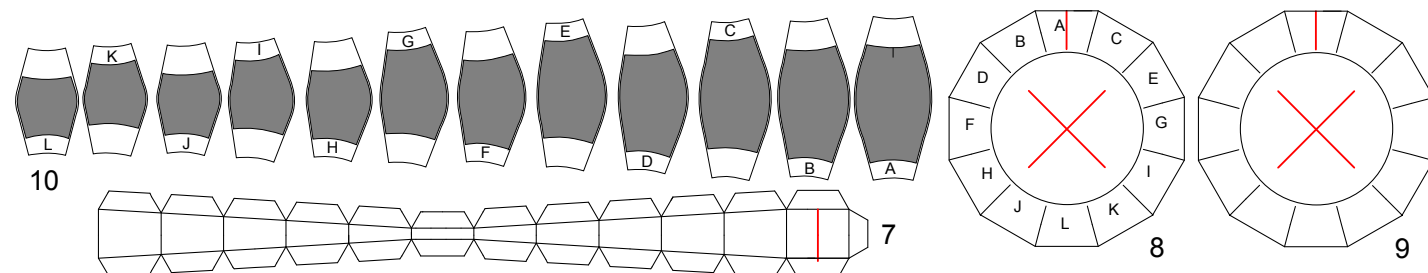
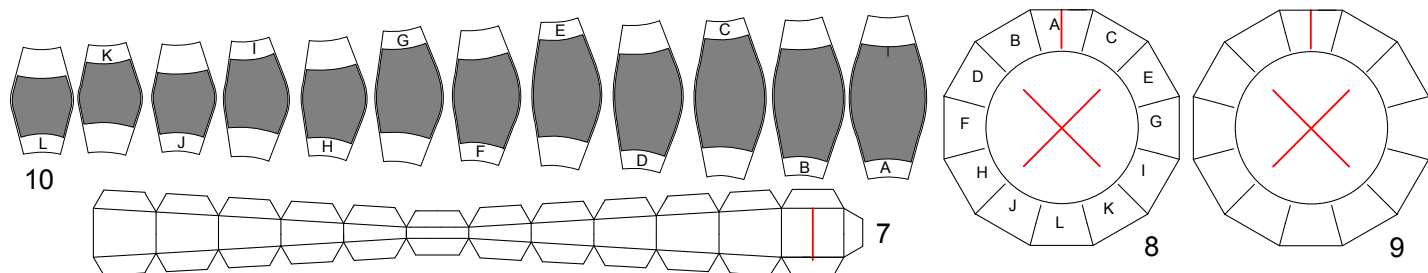
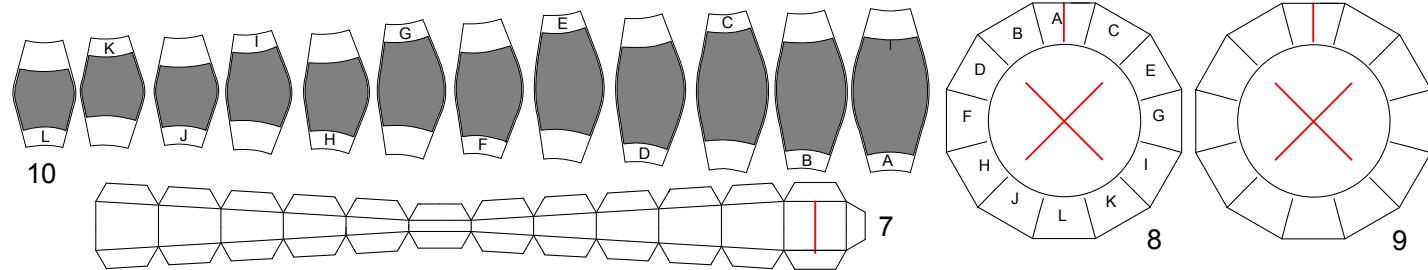
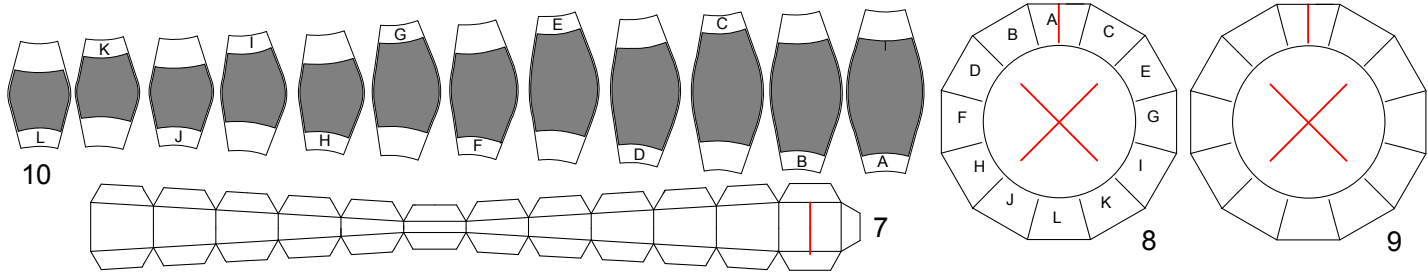

Apollo / Saturn V

Scale 1:48 © Greelt A. Peterusma

J2 Engine Part

Print on 160 - 180 grams paper

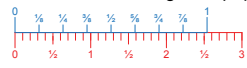

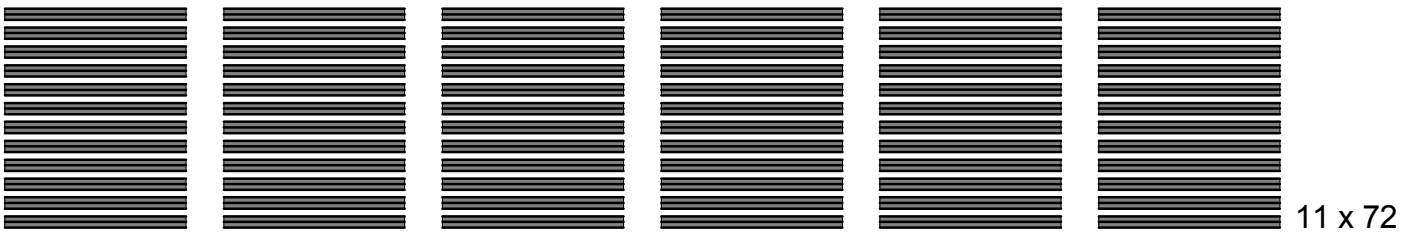
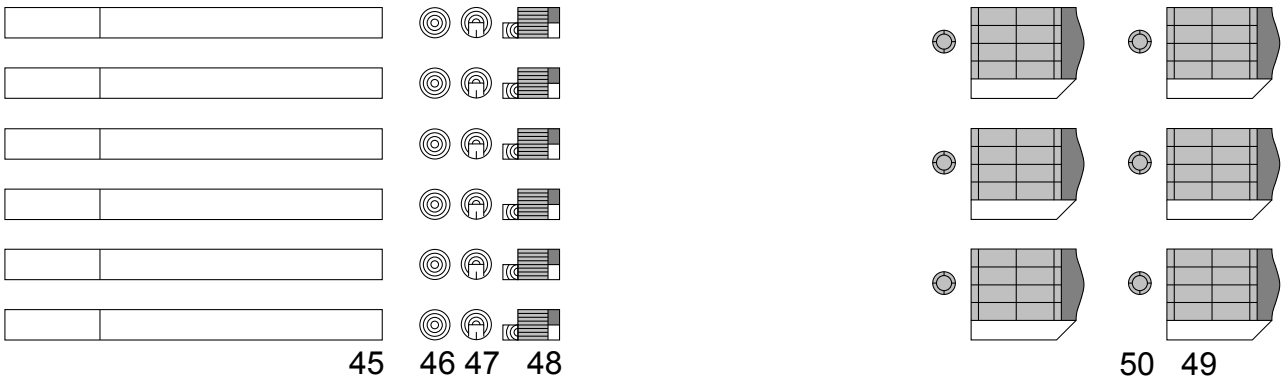
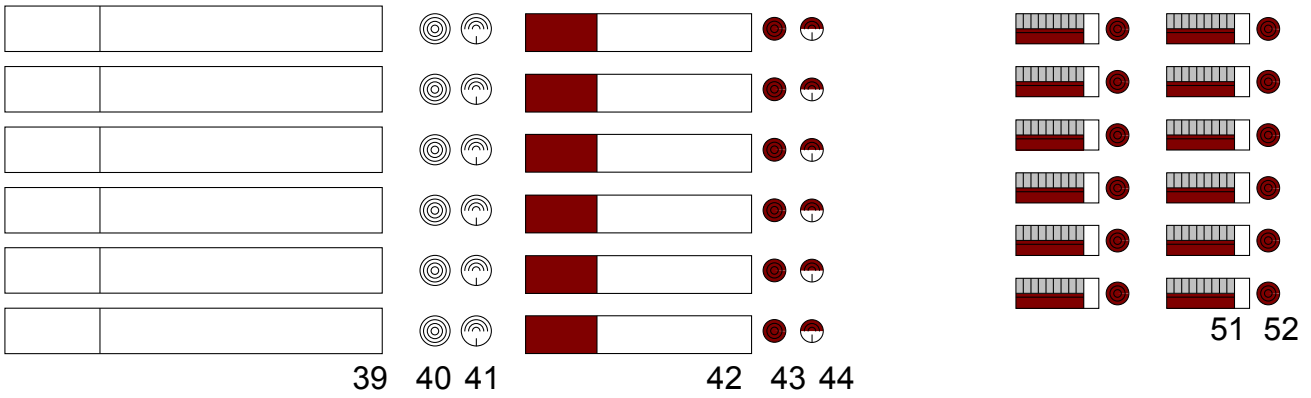
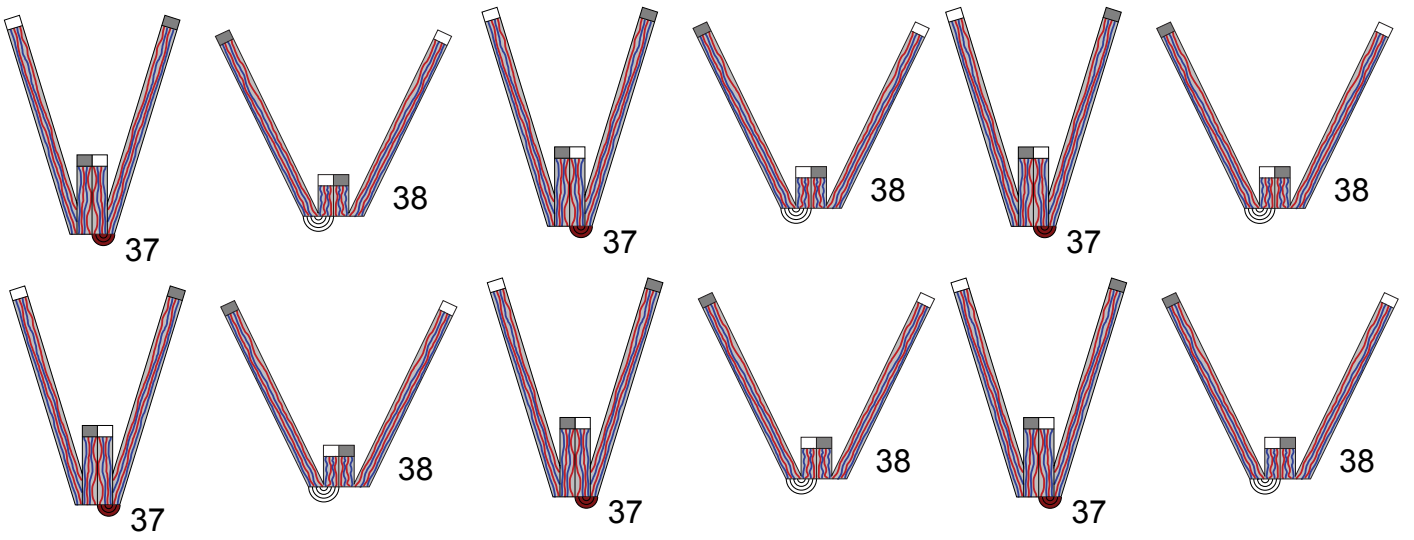

Apollo / Saturn V
 Scale 1:48 © Greelt A. Peterusma
 J2 Engine Part 3
 Print on 100 - 120 grams paper

Page 5

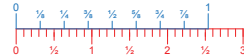

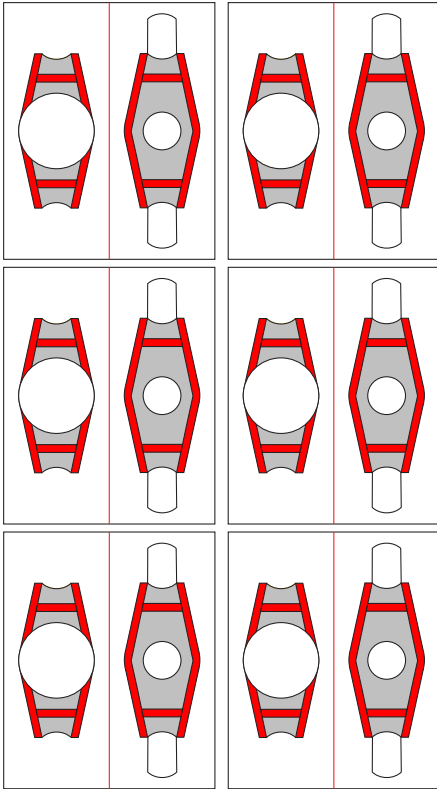

21

Fold on red line and glue before cutting out

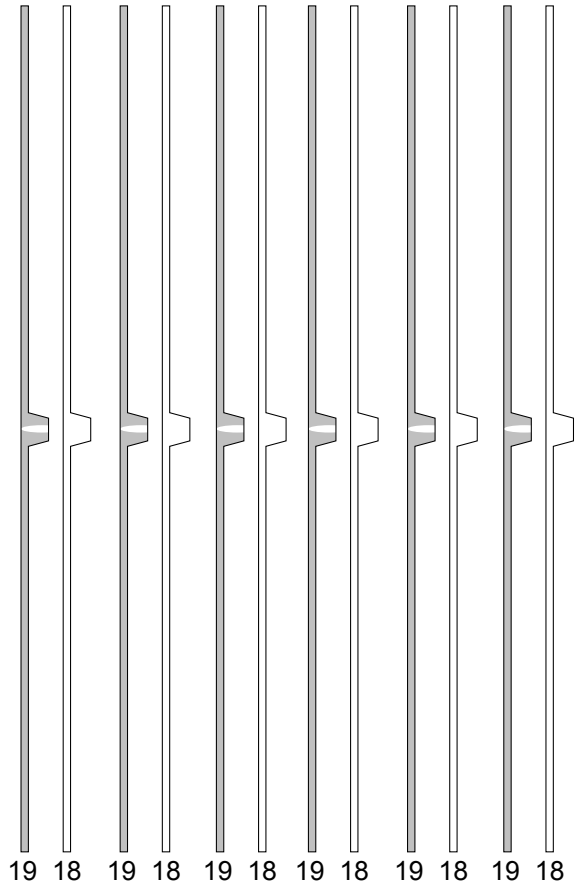

19 18 19 18 19 18 19 18 19 18 19 18

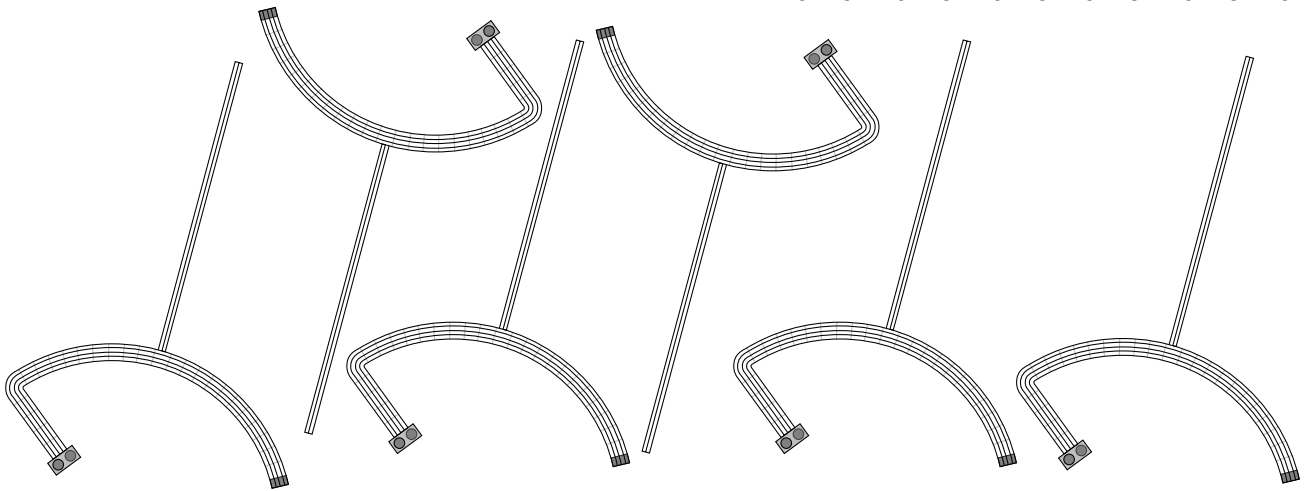

20 x 6

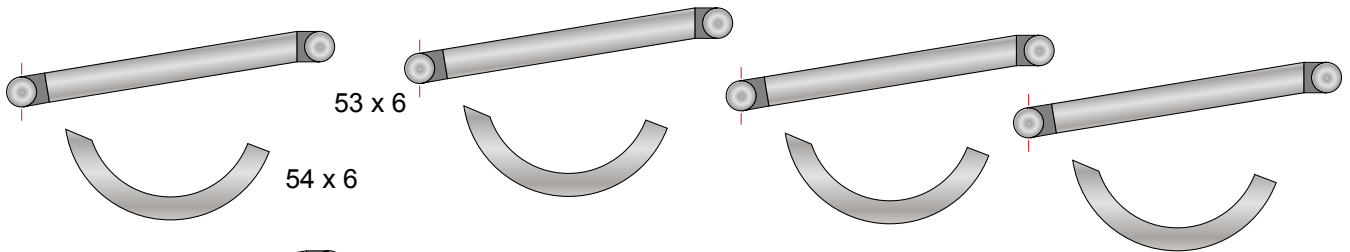

53 x 6

54 x 6

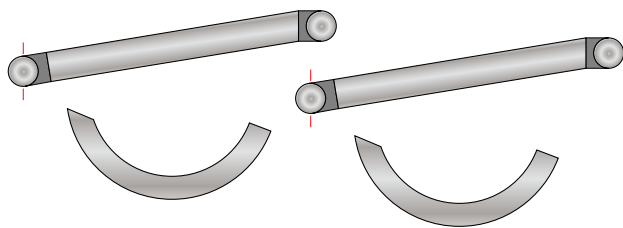

Apollo / Saturn V

Scale 1:48 © Greet A. Peterusma

J2 Engine Part 4

Print on 100 - 120 grams paper

Page 6

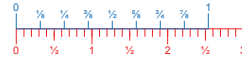

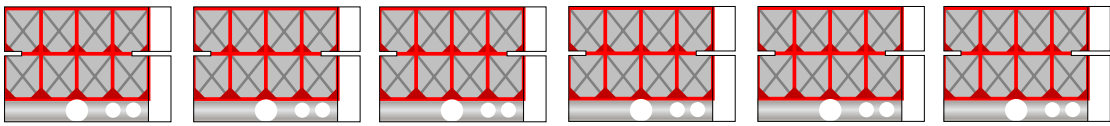

Cut slots (both sides) before rolling into a tube

22 x 6

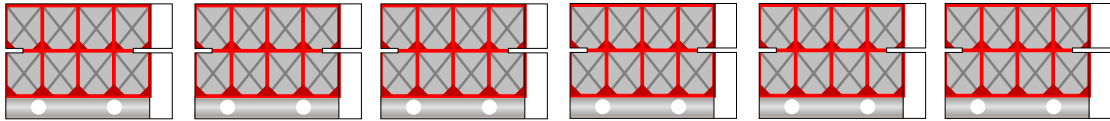

23 x 6

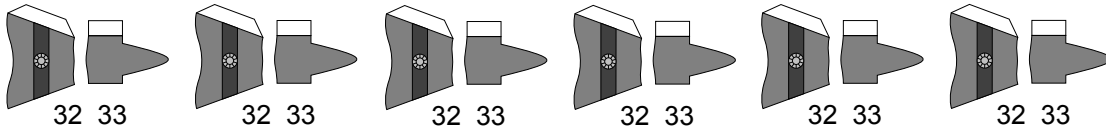

32 33

32 33

32 33

32 33

32 33

32 33

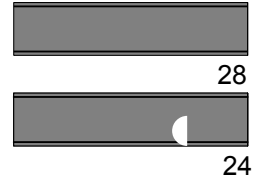

28

24

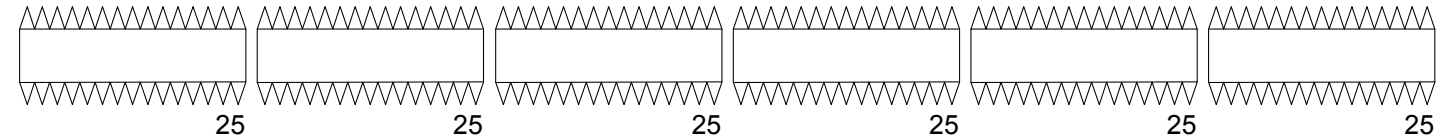

25

25

25

25

25

25

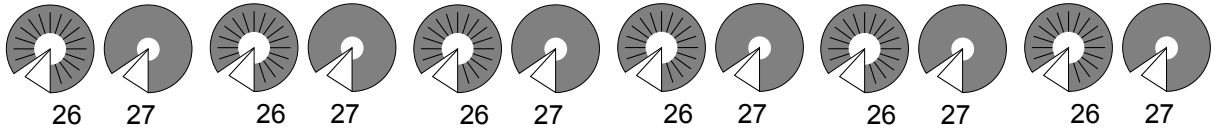

26

27

26

27

26

27

26

27

26

27

26

27



28

28

28

28

28

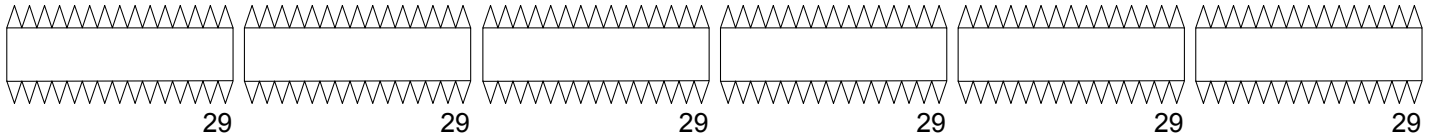

29

29

29

29

29

29

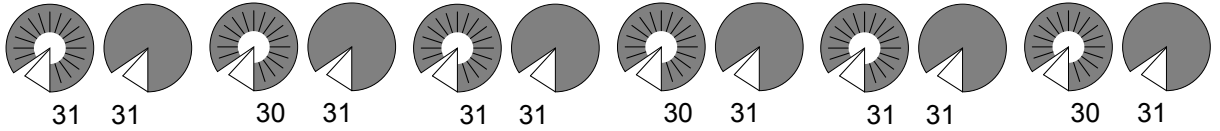

31

31

30

31

31

31

30

31

31

31

30

31

Score between red lines

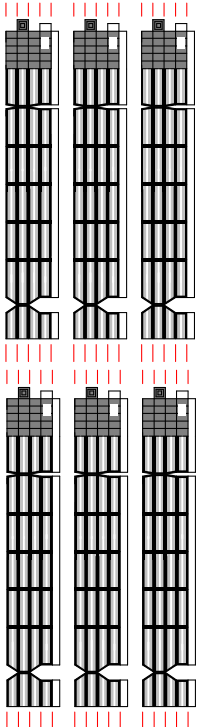

55 x 6

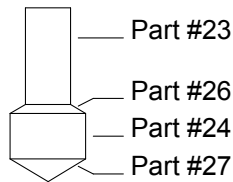

Part #23

Part #26

Part #24

Part #27

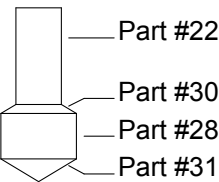

Part #22

Part #30

Part #28

Part #31

Make 6 combinations of the above parts

Make 6 combinations of the above parts

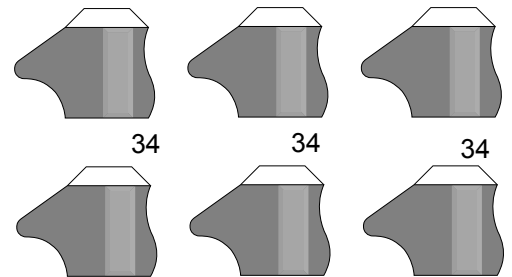

34

34

34

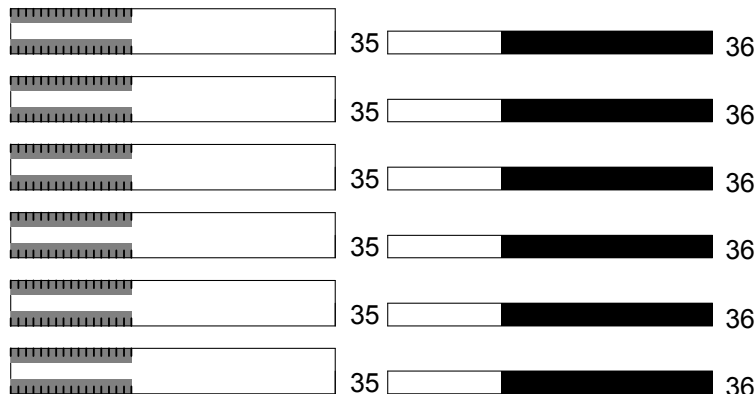

35

36

35

36

35

36

35

36

35

36

35

36



Page 7

Apollo / Saturn V

Scale 1:48 © Greelt A. Peterusma

J2 Engine Part 5

Print on 100 - 120 grams paper

